

BIKES | E-BIKES















2020



CONTENT

INTRO	2
BOSCH E-BIKE SYSTEMS	4
URBAN E-BIKE	14
SPECIAL E-BIKE	24
CITY E-BIKE	34
TREKKING E-BIKE	48
MTB & ATB E-BIKE	64
TREKKING BICYCLES	78
CROSS BICYCLES	94
MTB BICYCLES	104
URBAN & CITY BICYCLES	112
JUNIOR BICYCLES	122

LEGEND

 CHARGER	 BOSCH ACTIVE	 BOSCH PERFORMANCE CX	 BAFANG MID-DRIVE	 DECAL COLOR
 BATTERY	 BOSCH ACTIVE PLUS	 BOSCH PERFORMANCE	 BOSCH PERFORMANCE SPEED	 FRAME COLOR
 DISPLAY	 BAFANG HUB MOTOR	 COASTER BREAK	 SPEED PEDELEC	 FORK COLOR

The contents of the catalogue have been prepared with the greatest possible care. However, the provider assumes no liability for the accuracy, completeness and actuality of the content provided. Mistakes and changes are reserved. Copyright of the photos on pages of 4, 48, 64 -Lajos Sidlovszky.

GEPIDA E-BIKES EPOWERED BY BOSCH



Defining modern-day mobility: **the eBike is more than just another mode of transport. It is a new way of living and moving** - offering you ease and enjoyment in movement and allowing you to be active yet completely relaxed. It also gives you the enjoyment of knowing that your voyages of discovery are extremely environmentally friendly. This is equally true whether you're riding in the city or off-road. eBiking epowered by Bosch - now with new products and functions that take eMountain biking to a new level, ensure sustainable and efficient mobility while connecting eBikers with the digital world.

epowered by



BOSCH

INNOVATIONS AT A GLANCE: MODEL YEAR 2020



Performance Line CX

For the perfect Uphill Flow: The Red Dot Award-winning, new Performance Line CX for eMountain bikers is particularly lightSYSTEM and compact and has minimal pedal resistance.



Performance Line

For limitless freedom: The new Performance Line delivers the right support for every ride, whether on mountain rides or when commuting to work. It always offers a natural riding sensation up to 25 km/h and, in the Speed variant, up to 45 km/h.



PowerTubes

Stylish riding enjoyment: The integrated rechargeable batteries provide enough power for any ride. Now available in new variant: PowerTube 400 with even more power for maximum ranges and altitudes.



Lock

For a feeling of safety: The new premium function from Bosch is the ideal complement to a mechanical lock. Lock enables motor support to be deactivated by removing the Kiox on-board computer.

RIDING MODES AND RANGES BASED ON USING BOSCH E-BIKE SYSTEM

What is the range of a single battery charge? This is a common question for many eBikers. There is no definitive answer. The number and variety of influential factors is simply too great. Sometimes a single battery charge will take you less than 20 kilometres, while at other times it will take you up to 80 kilometres. However, following a few tips can easily help maximise the range of the battery.

Turbo:	Direct support at maximum power up to highest cadence for sporty riding
Sport*:	Powerful support for universal usage for both sporty riding and fast commuting in urban traffic
eMTB*:	Progressive support for a natural riding sensation and optimal control on demanding terrain
Tour:	Uniform support for rides with long ranges
Eco:	Effective support with maximum efficiency for the highest range
Off:	No support but all on-board computer functions can still be accessed

*Depending on the eBike type, the eMTB mode replaces the Sport mode in the Performance Line and the Performance Line CX

The range of the Bosch eBike system is largely dependent on the level of support. A choice of five different riding modes is available, each of which is described below. The graphic shows their effect on the range when conditions are favorable (light blue) and difficult (dark blue). These conditions are subsequently explained in the table.

Calculate your approximate range using the range assistant: bosch-ebike.com/range



PowerPack 500 or PowerTube 500 (using Active Line Drive Unit)

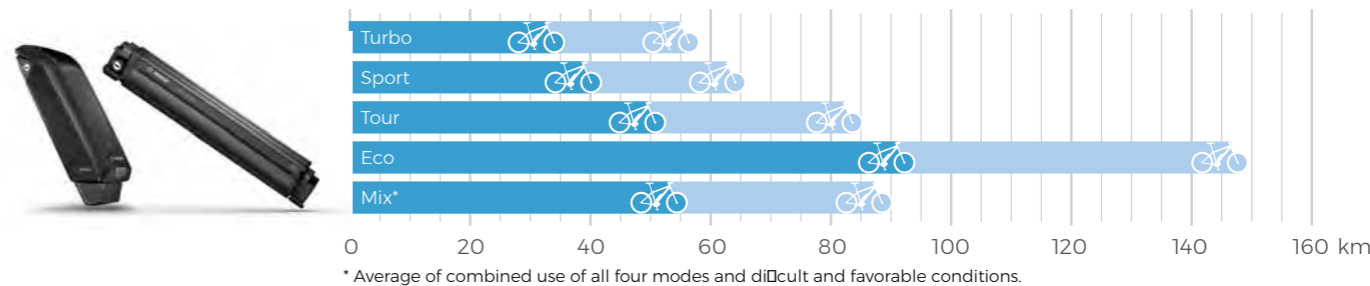

PowerPack 400 or PowerTube 400

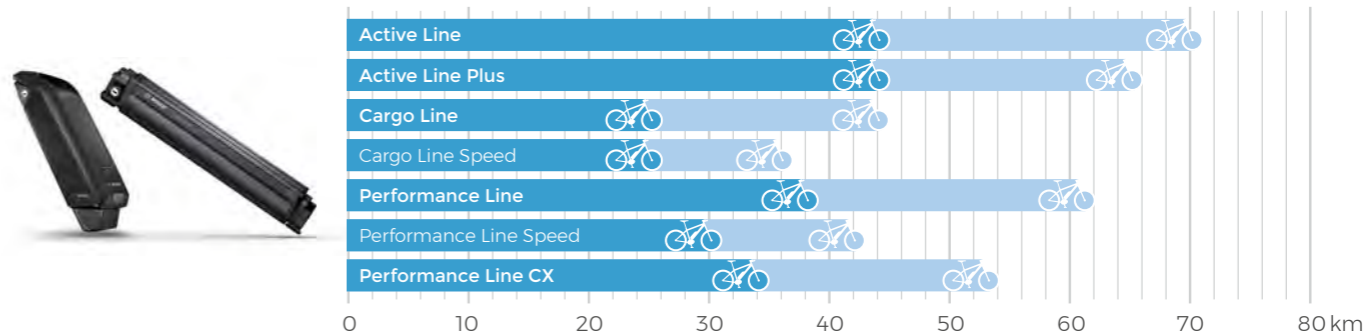

	Rider			eBike				Environment			
	Cadence	Rider weight (overall weight consisting of rider incl. eBike and luggage)	Rider type/ rider performance	Bosch eBike system	Shifting system	Tyre tread	Wheel type	Terrain type	Surface	Starting up frequency	Wind conditions
Difficult conditions**	70-90 rpm	115 kg 170 kg (Cargo Line)	Average	Drive unit, battery and Intuvia	Derailleur system	MTB tyres	MTB	Low mountain ranges	Dirt tracks and off-road trails (e.g. trails)	Bike ride with regular standing starts	Moderate wind
Favorable conditions**	50-70 rpm	105 kg 150 kg (Cargo Line)	Average	Drive unit, battery and Intuvia	Derailleur system	Trekking tyres	Touring bike	Hilly	Mainly gravel and paved forest paths	Bike ride with occasional standing starts	Slight wind

**The ranges are typical values of the new batteries, which may decrease if one of the conditions listed above deteriorates.

ESTIMATED RANGE OF BOSCH BATTERIES (MIXED MODES)*

The range of the batteries depends on their own capacity, riding modes, but also on the drive unit.

* Average of combined use of all four modes and favorable conditions.

Favorable conditions**	Rider			eBike				Environment			
	Cadence	Rider weight (overall weight consisting of rider incl. eBike and luggage)	Rider type/ rider performance	Bosch eBike system	Shifting system	Tyre tread	Wheel type	Terrain type	Surface	Starting up frequency	Wind conditions
	50-70 rpm	105 kg 150 kg (Cargo Line)	Average	Drive unit, battery and Intuvia	Derailleur system	Trekking tyres	Touring bike	Hilly	Mainly gravel and paved forest paths	Bike ride with occasional standing starts	Slight wind

**The ranges are typical values of the new batteries, which may decrease if one of the conditions listed above deteriorates.



Active Line

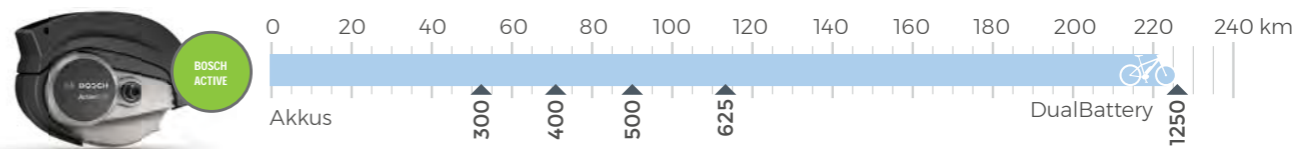

Active Line Plus

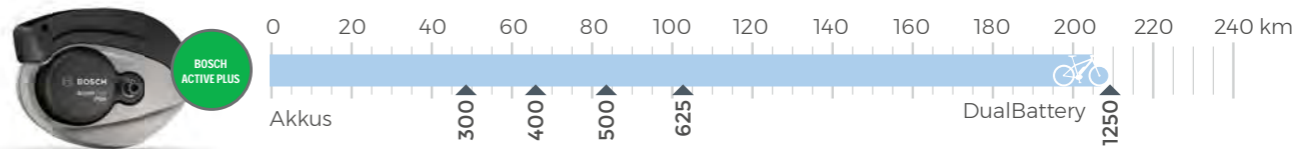

Performance Line

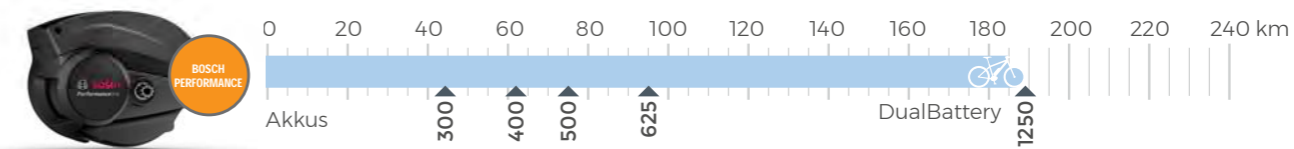

Performance Line CX

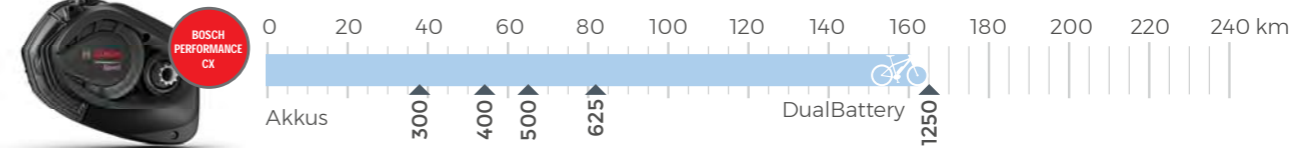

Performance Line Speed

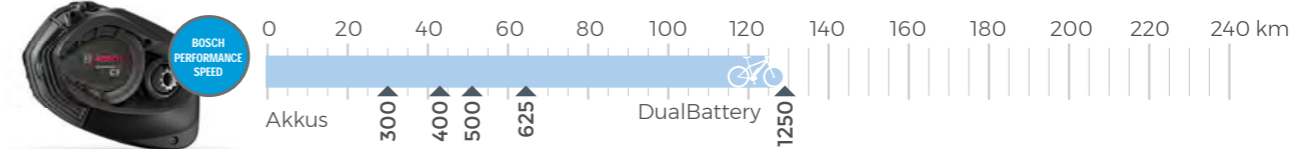

CARE

HOW TO INCREASE THE SERVICE LIFE OF THE BATTERY



The Bosch battery is an important eBike component, and with the correct care you can optimise its life.

Charging – The batteries should be charged at room temperature in a dry location where a smoke detector is installed.

Storage during winter – Store the batteries in a dry location at room temperature. Fully charging or fully discharging results in higher loading of the battery. The ideal charge status for lengthy periods of storage is approx. 30 to 60 % or two to three LEDs on the battery indicator.

Cleaning & care – We recommend using a damp cloth to clean the battery. The terminals should be cleaned occasionally and lightly greased. The battery should be removed before cleaning the eBike. To protect the electronic components, batteries must not be cleaned with direct water contact.

Winter use – During winter use (particularly below 0 °C) we recommend charging and storing the battery at room temperature before inserting the battery in the eBike immediately before riding it. For longer journeys in the cold, it is advisable to use thermal protective covers.

SERVICE LIFE

TIPS FOR MAXIMISING YOUR CHARGE

The service life of Bosch batteries is influenced primarily by the type and duration of the load. Like any lithium-ion battery, a Bosch battery naturally ages, even when not in use. Over time, its capacity diminishes.



Factors that shorten the service life:

- Heavy-load use
- Storage at over 30 °C ambient temperature
- Prolonged storage in a fully charged or fully discharged state
- Parking the eBike in direct sunlight



Factors that extend the service life:

- Low-load use
- Storage at a temperature between 0 and 20 °C
- Storage at approx. 30 – 60 % charge status
- Parking the eBike in the shade or a cool location

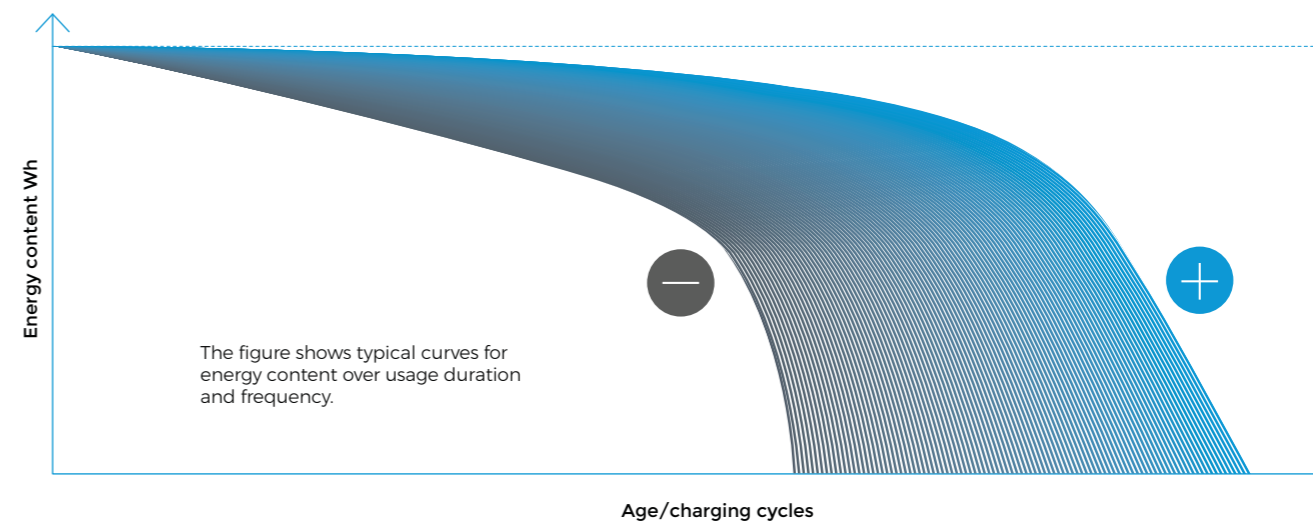

10 REASONS FOR CHOOSING AN EBIKE

eBiking is proving very popular. For young or old, for urban or sporty use, the eBike's electric power boost makes cycling more relaxing, you travel longer distances and you reach your destination feeling fresher. What began as a niche movement has become a trend.



1 The environment benefits

Pedelec users go easy on the environment, especially if they use their eBike on a daily basis. Half of all car journeys are five kilometres or less, and according to the Environmental Protection Agency the CO2 emissions of a car are around 40 times higher than those of a bicycle with a battery-powered motor. So by using an eBike rather than a car for short distances you are protecting the environment – and also travelling quietly and economically.

2 Gone are the days of headwinds

Who would not on occasion have appreciated a little assistance cycling on steep ascents in a full-on headwind? An invisible “hand” to give you a gentle push and make starting on an uphill stretch or cycling on a steep ascent almost effortless. Making mountains no longer daunting and headwinds neither here nor there. The eBike makes it possible.

3 Keeps you fit, makes you mobile

Are eBikes just for those who want to take it easy? Not at all! Despite the power assistance eBikers still have to hit the pedals to get moving. And it is up to you to decide how much power assistance you want or need. Studies have found that eBikers get on their bikes more often and cover much longer distances than conventional cyclists. So now is the time to get on a bike with power assistance regardless whether for comfort or for sporting use.

4 Perfect for commuting

Would you like to keep fit on your commute? Then the eBike is for you. It is a sporting option. eBikes are ideal for distances of this kind.

5 Easement, exercise, extra boost

Thanks to the even, adjustable assistance provided by the eBike drive system an eBike is ideal for training or for getting back into cycling after an injury. Furthermore, the drive system prevents too heavy a burden on knees or thigh muscles. That eases pressure on joints, tendons and ligaments. Would you like to be fit and healthy and to improve your wellbeing? An eBike is a step in the right direction.

6 Wheely good advice

Could you do without discussions and complaints? No arguments, please? The mood can turn fast when people with unequal physical conditions and expectations set out on a cycling tour together. That is when a little motor can work wonders. Its power assistance offsets differences in performance and brings people closer together again – with the result that the tour is an experience everyone is happy to repeat.

7 Easy on the wallet

eBikes are much less expensive than cars to buy and to maintain. Fuel costs, insurance premiums, car tax or parking charges? Zero. The cost of fuel alone for a gasoline-powered car is currently around €12 per 100 km. 100 km on a pedelec costs around €0.25. Now that is a genuine saving. Plans already?

8 Fun factor

eBikes make cycling less work and more fun. With power assistance the eBiker can sail past many other road users freely and easily. The pedelec is often the fastest mode of transport available in urban traffic over distances of up to and including 5 km – and over distances of up to 10 km eBikers can easily keep up with car drivers.

9 Pure mobility

Intermodal traffic? Not the slightest problem with an eBike. eBike to the railroad station, take the train and then either use public transportation or rent a pedelec to your destination. With an eBike you are fast and flexible. You can cover distances more easily and increase the radius of distances you can travel. Power assistance gives you a real boost in the city. eBikers leave tailbacks behind them and don't need to worry about finding somewhere to park either.

10 Something for everybody

The market is constantly coming up with new models and versions. Pedelecs capable of speeds of up to either 25 km/h or 45 km/h. eBikes are available for urban or cross-country use, for leisure tours or for summiteers with sporting ambitions. There is a wide range from which to choose and the right eBike for every kind.



URBAN

FAST, STYLISH, URBAN

We recommend you all members of the Urban E-Bike category, be it going to work or arranging your daily to-dos. High quality and unique design enable quick and stylish pedalling through the streets. Due to the electric assistance, you can also cover greater distances without mentionable physical effort, so you can arrive at the first morning meeting even in a suit or costume in top shape.

URBAN E-BIKE

BONUM PRO SLX 10



△ FRAME	GEPIDA GRAVITY CASTING - 6061 ALLOY	⊗ REAR SHOCK	-
△ FRAME SIZE	W: 46, 49, 53, 57CM	⚙ REAR DERAILLEUR	SHIMANO SLX SHADOW RD-M670 10S
└ FORK	SUNTOUR NRX-E AIR DS LO 700C, TRAVEL: 63MM ALLOY STEERER	🔒 BRAKE	SHIMANO ACERA BR-MT400
○ WHEEL SIZE	28"	🌀 TYRE	SCHWALBE ENERGIZER 40-622 W / REFLECTIVE TAPE
⚙ GEARS	10	📜 SADDLE	SELLE ROYAL SCIENTIA M3
⚡ SYSTEM	BOSCH	💡 LIGHT	TRELOCK PRIO 50LUX / TRELOCK LS611 6-12V

ARTICLE NUMBER
30202435

COLOR



30202435A



30202435B

HEADSET: FSA NO.11N SEMI-INTEGRATED | STEM: GEPIDA/TRANZX JD-ST103A EXT: 90/110MM 31,8MM | HANDLEBAR: TRANZX JD-TR23A 640MM BB: 31,8MM | GRIP: VELO VLG-649 AD2 | BRAKE LEVER: SHIMANO ACERA BL-MT400 | BRAKE DISC F/R: SHIMANO DEORE RT-54S 160MM | SHIFTING LEVER: SHIMANO DEORE SL-M6000 10S | SEATPOST: GEPIDA SP226 30,9X300MM | CRANKARM: FSA CK-310 170MM | CHAINWHEEL: FSA 18T STEEL | CASSETTE/COG: SHIMANO TIAGRA HG500-10 11-34T | CHAIN: SHIMANO DEORE CN-HG54 10S | RIM: RODI BLACKROCK 28" 622X21C EYELET, 32H | FRONT HUB: SHIMANO ALIVIO HB-M4050 QR 32H | REAR HUB: SHIMANO ALIVIO FH-M4050 QR 32H | SPOKE: SAPIM STAINLESS BLACK | RACK: GEPIDA ALLOY | MUDGUARD: CURANA D45 | CHAIN COVER: HORN CATENA | LOCK: ABUS BATTERY LOCK + 4960 | PEDAL: XERAMA SP-610 W/ CATEYE | KICKSTAND: HEBIE 668M1 18MM

Pictures shown here are for illustration purpose only. Actual product may vary due to specification enhancement.

BONUM PRO NEXUS 8

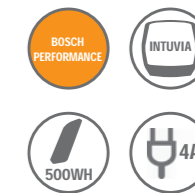

△ FRAME	GEPIDA GRAVITY CASTING - 6061 ALLOY	⊗ REAR SHOCK	-
△ FRAME SIZE	W: 46, 49, 53, 57CM	⚙ REAR DERAILLEUR	SHIMANO NEXUS 8
└ FORK	SUNTOUR NRX-E AIR DS LO 700C, TRAVEL: 63MM ALLOY STEERER	🔒 BRAKE	SHIMANO ACERA BR-MT400
○ WHEEL SIZE	28"	🌀 TYRE	SCHWALBE ENERGIZER 40-622 W / REFLECTIVE TAPE
⚙ GEARS	8	📜 SADDLE	SELLE ROYAL SCIENTIA M3
⚡ SYSTEM	BOSCH	💡 LIGHT	TRELOCK PRIO 50LUX / TRELOCK LS611 6-12V

ARTICLE NUMBER
30202455

COLOR

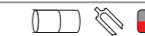

30202455A



30202455B

HEADSET: FSA NO.11N SEMI-INTEGRATED | STEM: GEPIDA/TRANZX JD-ST103A EXT: 90/110MM 31,8MM | HANDLEBAR: TRANZX JD-TR23A 640MM BB: 31,8MM | GRIP: VELO VLG-649 AD2 | BRAKE LEVER: SHIMANO ACERA BL-MT400 | BRAKE DISC F/R: SHIMANO DEORE RT-54S 160MM | SHIFTING LEVER: SHIMANO NEXUS 8 REVOSHIFT SL-C6000 | SEATPOST: GEPIDA SP226 30,9X300MM | CRANKARM: FSA CK-310 170MM | CHAINWHEEL: FSA 18T STEEL | CASSETTE/COG: SHIMANO 19T | CHAIN: KMC Z610 XEPT | RIM: RODI BLACKROCK 28" 622X21C EYELET, 32H | FRONT HUB: SHIMANO ALIVIO HB-M4050 QR 32H | REAR HUB: SHIMANO NEXUS 8 DISC SC-C6001-8D 32H | SPOKE: SAPIM STAINLESS BLACK | RACK: GEPIDA ALLOY | MUDGUARD: CURANA D45 | CHAIN COVER: HORN CATENA | LOCK: ABUS BATTERY LOCK + 4960 | PEDAL: XERAMA SP-610 W/ CATEYE | KICKSTAND: HEBIE 668M1 18MM

Pictures shown here are for illustration purpose only. Actual product may vary due to specification enhancement.

BONUM SLX 10



△ FRAME	GEPIDA HYDROFORMING - 6061 ALLOY	⊗ REAR SHOCK	-
△ FRAME SIZE W:	46, 49, 53CM	⚙ REAR DERAILLEUR	SHIMANO SLX SHADOW RD-M670 10S
⌒ FORK	SUNTOUR NRX-E AIR DS LO 700C, TRAVEL: 63MM ALLOY STEERER	🔧 BRAKE	SHIMANO ACERA BR-MT400
○ WHEEL SIZE 28"		🛞 TYRE	SCHWALBE ENERGIZER 40-622 W / REFLECTIVE TAPE
⚙ GEARS	10	🪘 SADDLE	SELLE ROYAL SCIENTIA M3
🔋 SYSTEM	BOSCH	💡 LIGHT	TRELOCK PRIO 50LUX / TRELOCK LS611 6-12V

ARTICLE NUMBER	COLOR				
30202405	<table border="0"> <tr> <td></td> <td>30202405A</td> <td></td> <td>30202405B</td> </tr> </table>		30202405A		30202405B
	30202405A		30202405B		

HEADSET: FSA NO.11N SEMI-INTEGRATED | STEM: GEPIDA/TRANZX JD-ST103A EXT: 90/110MM 31,8MM | HANDLEBAR: TRANZX JD-TR23A 640MM BB: 31,8MM | GRIP: VELO VLG-649 AD2 | BRAKE LEVER: SHIMANO ACERA BL-MT400 | BRAKE DISC F/R: SHIMANO DEORE RT-54S 160MM | SHIFTING LEVER: SHIMANO DEORE SL-M6000 10S | SEATPOST: GEPIDA SP226 30,9X300MM | CRANKARM: FSA CK-310 170MM | CHAINWHEEL: FSA 18T STEEL | CASSETTE/COG: SHIMANO TIAGRA HG500-10 11-34T | CHAIN: SHIMANO DEORE CN-HG54 10S | RIM: RODI BLACKROCK 28" 622X21C EYELET, 32H | FRONT HUB: SHIMANO ALIVIO HB-M4050 QR 32H | REAR HUB: SHIMANO ALIVIO FH-M4050 QR 32H | SPOKE: SAPIM STAINLESS BLACK | RACK: GEPIDA ALLOY | MUDGUARD: CURANA D45 | CHAIN COVER: HORN CATENA | LOCK: ABUS BATTERY LOCK + 4960 | PEDAL: XERAMA SP-610 W/ CATEYE | KICKSTAND: HEBIE 668M1 18MM

Pictures shown here are for illustration purpose only. Actual product may vary due to specification enhancement.

BONUM NEXUS 8



△ FRAME	GEPIDA HYDROFORMING - 6061 ALLOY	⊗ REAR SHOCK	-
△ FRAME SIZE W:	46, 49, 53CM	⚙ REAR DERAILLEUR	SHIMANO NEXUS 8
⌒ FORK	SUNTOUR NRX-E AIR DS LO 700C, TRAVEL: 63MM ALLOY STEERER	🔧 BRAKE	SHIMANO ACERA BR-MT400
○ WHEEL SIZE 28"		🛞 TYRE	SCHWALBE ENERGIZER 40-622 W / REFLECTIVE TAPE
⚙ GEARS	8	🪘 SADDLE	SELLE ROYAL SCIENTIA M3
🔋 SYSTEM	BOSCH	💡 LIGHT	TRELOCK PRIO 50LUX / TRELOCK LS611 6-12V

ARTICLE NUMBER	COLOR				
30202415	<table border="0"> <tr> <td></td> <td>30202415A</td> <td></td> <td>30202415B</td> </tr> </table>		30202415A		30202415B
	30202415A		30202415B		

HEADSET: FSA NO.11N SEMI-INTEGRATED | STEM: GEPIDA/TRANZX JD-ST103A EXT: 90/110MM 31,8MM | HANDLEBAR: TRANZX JD-TR23A 640MM BB: 31,8MM | GRIP: VELO VLG-649 AD2 | BRAKE LEVER: SHIMANO ACERA BL-MT400 | BRAKE DISC F/R: SHIMANO DEORE RT-54S 160MM | SHIFTING LEVER: SHIMANO NEXUS 8 REVOSHIFT SL-C6000 | SEATPOST: GEPIDA SP226 30,9X300MM | CRANKARM: FSA CK-310 170MM | CHAINWHEEL: FSA 18T STEEL | CASSETTE/COG: SHIMANO 19T | CHAIN: KMC Z610 XEPT | RIM: RODI BLACKROCK 28" 622X21C EYELET, 32H | FRONT HUB: SHIMANO ALIVIO HB-M4050 QR 32H | REAR HUB: SHIMANO NEXUS 8 DISC SC-C6001-8D 32H | SPOKE: SAPIM STAINLESS BLACK | RACK: GEPIDA ALLOY | MUDGUARD: CURANA D45 | CHAIN COVER: HORN CATENA | LOCK: ABUS BATTERY LOCK + 4960 | PEDAL: XERAMA SP-610 W/ CATEYE | KICKSTAND: HEBIE 668M1 18MM

Pictures shown here are for illustration purpose only. Actual product may vary due to specification enhancement.

BONUM CURVE NEXUS 8



△ FRAME	GEPIDA HYDROFORMING - 6061 ALLOY	⊗ REAR SHOCK	-
△ FRAME SIZE	W: 46, 49, 53, 57CM	⚙ REAR DERAILLEUR	SHIMANO NEXUS8
⌒ FORK	SUNTOUR NEX DS-700C 28" A-HEAD TRAVEL: 63 MM	🔧 BRAKE	TEKTRO HDT275
○ WHEEL SIZE	28"	🌀 TYRE	SCHWALBE ENERGIZER 622-47 W/ REFELCTIVE TAPE
⚙ GEARS	8	📉 SADDLE	SELLE ROYAL ESSENZA
⚡ SYSTEM	BOSCH	💡 LIGHT	AXA BLUELINE 30 / TRELOCK LS611 6-12V
ARTICLE NUMBER	30201425		
	COLOR		
	30201425A	30201425B	

HEAD SET: FSA NO.11N SEMI INTEGRATED | STEM: KALLOY AS601 BB: 25,4MM EXT: 90 MM 15 DEG | HANDLE BAR: GEPIDA NR-AL14 W: 630MM BB: 25,4MM | GRIP: VELO VLG-690 AD2 | BRAKE LEVER: TEKTRO HDT275 | BRAKE DISC F/R: 160 MM | SHIFTING LEVER: SHIMANO NEXUS 8 REVOSHIFT SL-C6000 8S | SEAT POST: ZOOM SP-C207 30,9X350 MM | CRANKARM: FSA 38T DIRECT MOUNT STEEL | CHAINWHEEL: FSA 38T INTEGRATED | CASSETTE/COG: SHIMANO 19T | CHAIN: KMC Z50 | RIM: RODI BLACKROCK 29" 622X21C 32H | FRONT HUB: FORMULA CL-51 QR 32H | REAR HUB: SHIMANO NEXUS 8 DISC SG-C6001-8D 32H | SPOKE: SAPIM STAINLESS STEEL BLACK | RACK: MASSLOAD CL-549 | MUDGUARD: SKS 55 MM, BLACK STAYS | CHAIN GUARD: HESLING SUPORTIVE V2 | LOCK: ABUS BATTERY LOCK | PEDAL: XERAMA SP-811 ALLOY W / CATEYE | KICKSTAND: STANDWELL SW-RA031J ADJUSTABLE

Pictures shown here are for illustration purpose only. Actual product may vary due to specification enhancement.

BONUM CURVE ALTUS 9

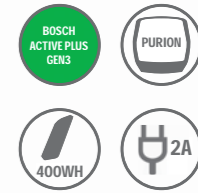

△ FRAME	GEPIDA HYDROFORMING - 6061 ALLOY	⊗ REAR SHOCK	-
△ FRAME SIZE	W: 46, 49, 53, 57CM	⚙ REAR DERAILLEUR	SHIMANO ALTUS RD-M2000, SGS 9-SPEED, SHADOW DESIGN
⌒ FORK	SUNTOUR NEX DS-700C 28" A-HEAD TRAVEL: 63 MM	🔧 BRAKE	TEKTRO HDT275
○ WHEEL SIZE	28"	🌀 TYRE	SCHWALBE ENERGIZER 622-47 W/ REFELCTIVE TAPE
⚙ GEARS	9	📉 SADDLE	SELLE ROYAL ESSENZA
⚡ SYSTEM	BOSCH	💡 LIGHT	AXA BLUELINE 30 / TRELOCK LS611 6-12V
ARTICLE NUMBER	30201465		
	COLOR	COLOR	
	30201465A	30201465B	

HEAD SET: FSA NO.11N SEMI INTEGRATED | STEM: KALLOY AS601 BB: 25,4MM EXT: 90 MM 15 DEG | HANDLE BAR: GEPIDA NR-AL14 W: 630MM BB: 25,4MM | GRIP: VELO VLG-690 AD2 | BRAKE LEVER: TEKTRO HDT275 | BRAKE DISC F/R: TEKTRO 160MM | SHIFTING LEVER: SHIMANO ALTUS SL-M2010 9S | SEAT POST: ZOOM SP-C207 30,9X350 MM | CRANKARM: FSA CK-200 170MM | CHAINWHEEL: FSA 38T DIRECT MOUNT STEEL | CASSETTE/COG: SHIMANO ACERA CS-HG200 11-34T 9S | CHAIN: SHIMANO CN-HG53 9S | RIM: RODI BLACKROCK 29" 622X21C 32H | FRONT HUB: FORMULA DC-20LW QR 32H | REAR HUB: FORMULA DC-22W QR 32H | SPOKE: SAPIM STAINLESS STEEL BLACK | RACK: MASSLOAD CL-549 | MUDGUARD: SKS 55 MM, BLACK STAYS | CHAIN GUARD: HESLING SUPORTIVE V2 | LOCK: ABUS BATTERY LOCK | PEDAL: XERAMA SP-811 ALLOY W / CATEYE | KICKSTAND: STANDWELL SW-RA031J ADJUSTABLE

Pictures shown here are for illustration purpose only. Actual product may vary due to specification enhancement.

PUGIO NEXUS 7



△ FRAME	6061 ALLOY	⊗ REAR SHOCK	-
△ FRAME SIZE	17"	⚙ REAR DERAILLEUR	SHIMANO NEXUS 7
└ FORK	GEPIDA RIGID 6061 ALLOY	🔧 BRAKE	TEKTRO HD-M275
○ WHEEL SIZE	20"	🌀 TYRE	SCHWALBE BIG APPLE 20X2,15 W/ REFLECTIVE TAPE
⚙ GEARS	7	📂 SADDLE	SELLE ROYAL ARIEL HRC ACTEX COVER
⚡ SYSTEM	BOSCH	💡 LIGHT	AXA BLUELINE 30 / TRELOCK LS611 6-12V
ARTICLE NUMBER		COLOR	
30201550		30201550A	

HEADSET: FSA NO.11N | STEM: JD ST103-A1 | HANDLEBAR: PROMAX HB-3188 RIZER 640MM BB: 31,8MM | GRIP: VELO VLG-690AD2 | BRAKE LEVER: TEKTRO HD-M275 | BRAKE DISC F/R: TEKTRO 160MM | SHIFTING LEVER: SHIMANO NEXUS 7 REVOSHIFT SL-C3000 | SEATPOST: KALLOY SPDC1 30,9X400MM | CRANKARM: FSA CK-200 170MM | CHAINWHEEL: FSA 44T STEEL | CASSETTE/COG: SHIMANO 17T | CHAIN: KMC Z50 | RIM: RODI WEB DISC 32H | FRONT HUB: FORMULA CL-51 QR 32H | REAR HUB: SHIMANO NEXUS 7 DISC SG-C3001-7D | SPOKE: SAPIM STAINLESS STEEL | RACK: - | MUDGUARD: SKS 55MM, BLACK STAYS | CHAIN GUARD: - | LOCK: ABUS BATTERY LOCK | PEDAL: XERAMA SP-811 ALLOY W/ CATEYE | KICKSTAND: STANDWELL SW-MA008 ADJUSTABLE

Pictures shown here are for illustration purpose only. Actual product may vary due to specification enhancement.

LEGIO PRO ALFINE 8

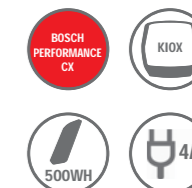

△ FRAME	GEPIDA GRAVITY CASTING - 6061 ALLOY	⊗ REAR SHOCK	-
△ FRAME SIZE	17" 19" 21"	⚙ REAR DERAILLEUR	SHIMANO ALFINE 8
└ FORK	GEPIDA 6061 ALLOY QR15	🔧 BRAKE	SHIMANO DEORE BR-MT 500
○ WHEEL SIZE	650B	🌀 TYRE	SCHWALBE SUPER MOTO X 27,5X2,4
⚙ GEARS	8	📂 SADDLE	SELLE ROYAL ARCO ASTRALE COVER
⚡ SYSTEM	BOSCH	💡 LIGHT	TRELOCK AIRFLOW 70 / TRELOCK LS631 6-12V
ARTICLE NUMBER		COLOR	
30202220		30202220A	

HEADSET: FSA NO.42ACB | STEM: ERGOTEC INTEGRA EXT: 100 MM | HANDLEBAR: PROMAX HB-3188 RIZER 720MM BB: 31,8MM | GRIP: VELO VLG-775-12D2 + VLP-171 | BRAKE LEVER: SHIMANO DEORE BL-MT 500 | BRAKE DISC F/R: SHIMANO DEORE RT-54S 160MM | SHIFTING LEVER: SHIMANO ALFINE 8 SL-S7000-8 | SEATPOST: KALLOY SPDC1 30,9X400MM | CRANKARM: FSA CK-310 170/175MM | CHAINWHEEL: FSA 18T STEEL | CASSETTE/COG: SHIMANO 19T | CHAIN: KMC Z610 XEPT | RIM: RODI BLACKROCK 27,5" 584X21C 32H | FRONT HUB: SHIMANO DEORE HB-M6010 QR15 32H | REAR HUB: SHIMANO ALFINE 8 SG-S7000-8 | SPOKE: SAPIM STAINLESS STEEL BLACK | RACK: STANDWELL SW-CA535S | MUDGUARD: SKS EVO AL 65MM, BLACK STAYS | CHAIN GUARD: HORN CATENA | LOCK: ABUS BATTERY LOCK | PEDAL: VP 536 | KICKSTAND: HEBIE 668M1 18MM

Pictures shown here are for illustration purpose only. Actual product may vary due to specification enhancement.



SPECIAL

2 IN 1

We are pursuing novelties, and we are doing so to optimise the utilisation. This is how our special category was developed, which is the boundary between trekking and city bikes. Touring or cruising in the city, or transport on two wheels with green energy? These are all there in this category.

SPECIAL E-BIKE

CARGO

The world is constantly changing, which calls for solutions to new ideas and demands that arise every day. We, at Gepida, are determined to provide a sustainable alternative for motorised vehicles that have high emission of CO₂ and other harmful substances. In addition to satisfying the public's dynamically increasing demand for e-bikes, we wanted to develop a product for actors in the industry and other professionals, that enables the transportation of oversized tools and packages that were previously transported by bicycles and scooters. We offer a complex solution to those who want to move cargo efficiently, without pollution, either indoors, or in limited access areas. The cargo makes it possible to work in areas that are difficult or impossible to access by cars. Last, but not least, work will be less like work when using an electric bicycle.

<http://gepida.com/cargo/>



CARGO NUVINCI 330



△ FRAME **GEPIDA HYDROFORMING - 6061 ALLOY**

△ FRAME SIZE **48CM**

∩ FORK **GEPIDA RIGID STEEL**

○ WHEEL SIZE **26"**

⚙ GEAR **GEARLESS (330%)**

⚡ SYSTEM **BOSCH**

ARTICLE NUMBER

30202505

⊖ REAR SHOCK **-**

⚙ REAR DERAILLEUR **NUVINCI INFINITY C3**

🚒 BRAKE **SHIMANO ACERA BR-MT400**

🌀 TYRE **SCHWALBE CRAZY BOB 26X2,35**

🚉 SADDLE **SELLE ROYAL TORX**

💡 LIGHT **AXA BLUELINE 30 *2/TRELOCK LS611 6-12V**

COLOR

 **30202505A**

HEADSET: FSA NO.11N | STEM: ERGOTEC SWELL-R ECO EXT: 80MM BB: 31,8MM | HANDLEBAR: ERGOTEC ERGO PLUS 650MM | GRIP: VELO VLG-649AD2S W/ CLAMP | BRAKE LEVER: SHIMANO ACERA BL-MT400 | BRAKE DISC F/R: SHIMANO DEORE RT-56M 180MM | SHIFTING LEVER: NUVINCI INFINITY C3 | SEATPOST: ERGOTEC SKALAR 30,9X400 | CRANKARM: FSA CK-632 170MM | CHAINWHEEL: FSA 18T STEEL | CASSETTE/COG: NUVINCI 20T | CHAIN: KMC Z610 XEPT | RIM: RODI VISION25 26" W/4D EYELET 36H | FRONT HUB: SHIMANO XT HB-M756 QR 6-BOLT 36H | REAR HUB: NUVINCI N330 DISC 6-BOLT 36H | SPOKE: SAPIM STAINLESS 13G BLACK | RACK: INTEGRATED FRONT AND REAR | MUDGUARD: SKS | CHAIN GUARD: HORN CATENA | LOCK: ABUS BATTERY LOCK + 4960 | PEDAL: XERAMA SP-811 ALLOY W/ CATEYE | KICKSTAND: HEBIE FOLDREX 608 80 HEAVY LOAD

Pictures shown here are for illustration purpose only. Actual product may vary due to specification enhancement.

TURISIND LS ALFINE 8



△ FRAME	GEPIDA SPECIAL HYDROFORMING - 6061 ALLOY
△ FRAME SIZE	M: 44, 48, 52, 56CM
∩ FORK	SUNTOUR NEX-E25 700C LO DS TRAVEL: 63MM
○ WHEEL SIZE	28"
⚙️ GEARS	8
⚡ SYSTEM	BOSCH

⊖ REAR SHOCK	-
⚙️ REAR DERAILLEUR	SHIMANO ALFINE 8
🔧 BRAKE	SHIMANO DEORE BR-M6000
🌀 TYRE	SCHWALBE ENERGIZER+ 47-622 W / REFLECTIVE TAPE
📂 SADDLE	SELLE ROYAL ARIEL HRC ACTEX COVER
💡 LIGHT	AXA BLUELINE 30 / TRELOCK LS611 6-12V

ARTICLE NUMBER
30202236

COLOR



HEADSET: FSA NO.11N | STEM: HL SATORI EZ3 ADJUSTABLE | HANDLEBAR: PROMAX HB-3188 RIZER 640MM BB: 31,8MM | GRIP: VELO VLG-775-12D2 + VLP-171 | BRAKE LEVER: SHIMANO DEORE BL-T6000 | BRAKE DISC F/R: SHIMANO DEORE RT-54S 160MM | SHIFTING LEVER: SHIMANO ALFINE 8 SL-S7000-8 | SEATPOST: TRANZX YSP-01 27,2X400MM | CRANKARM: FSA CK-200 170MM | CHAINWHEEL: FSA 44T STEEL | CASSETTE/COG: SHIMANO 19T | CHAIN: KMC Z610 XEPT | CHAIN GUARD: HESLING SUPORTIVE V2 44-46T | RIM: RODI VISION25 28" 622X25C EYELET, 36H | FRONT HUB: SHIMANO ALIVIO HB-M4050 QR 36H | REAR HUB: SHIMANO ALFINE 8 SG-S7001-8 36H | SPOKE: SAPIM STAINLESS 13G | RACK: MASSLOAD CL 905A | MUDGUARD: SKS 53MM, BLACK STAYS | LOCK: ABUS BATTERY LOCK | PEDAL: VP 831-P W/ CATEYE | KICKSTAND: HEBIE 668M1 18MM

Pictures shown here are for illustration purpose only. Actual product may vary due to specification enhancement.

TURISIND CITY ALFINE 8



△ FRAME	GEPIDA HYDROFORMING - 6061 ALLOY
△ FRAME SIZE	W: 46, 49, 53CM
∩ FORK	SUNTOUR NEX-E25 700C LO DS TRAVEL: 63MM
○ WHEEL SIZE	28"
⚙️ GEARS	8
⚡ SYSTEM	BOSCH

⊖ REAR SHOCK	-
⚙️ REAR DERAILLEUR	SHIMANO ALFINE 8
🔧 BRAKE	SHIMANO DEORE BR-M6000
🌀 TYRE	SCHWALBE ENERGIZER+ 47-622 W / REFLECTIVE TAPE
📂 SADDLE	SELLE ROYAL ARIEL HRC ACTEX COVER
💡 LIGHT	AXA BLUELINE 30 / TRELOCK LS611 6-12V

ARTICLE NUMBER
30202235

COLOR



HEADSET: FSA NO.11N | STEM: HL SATORI EZ3 ADJUSTABLE | HANDLEBAR: PROMAX HB-3188 RIZER 640MM BB: 31,8MM | GRIP: VELO VLG-775-12D2 + VLP-171 | BRAKE LEVER: SHIMANO DEORE BL-T6000 | BRAKE DISC F/R: SHIMANO DEORE RT-54S 160MM | SHIFTING LEVER: SHIMANO ALFINE 8 SL-S7000-8 | SEATPOST: TRANZX YSP-01 27,2X400MM | CRANKARM: FSA CK-200 170MM | CHAINWHEEL: FSA 44T STEEL | CASSETTE/COG: SHIMANO 19T | CHAIN: KMC Z610 XEPT | CHAIN GUARD: HESLING SUPORTIVE V2 | RIM: RODI VISION25 28" 622X25C EYELET, 36H | FRONT HUB: SHIMANO ALIVIO HB-M4050 QR 36H | REAR HUB: SHIMANO ALFINE 8 SG-S7001-8 36H | SPOKE: SAPIM STAINLESS 13G | RACK: MASSLOAD CL 905A | MUDGUARD: SKS 53MM, BLACK STAYS | CHAIN GUARD: HORN CATENA | LOCK: ABUS BATTERY LOCK | PEDAL: VP 831-P W/ CATEYE | KICKSTAND: HEBIE 668M1 18MM

Pictures shown here are for illustration purpose only. Actual product may vary due to specification enhancement.

THE GROUNDBREAKING BAFANG M800

for E-Road and Gravel bikes

The lightest and most compact middle-motor system designed for E-Road and E-Gravel bike use. This cutting-edge system features a seamlessly integrated downtube battery, an ergonomic handlebar remote and a centrally mounted color display.



Drive unit

The M800 drive unit has a clean, aerodynamic design. It's also super light, quiet with low mechanical resistance and compatible with a front two speeds chainwheel (34/50T).



DRIVE UNIT PERFORMANCE - M800

Rated Voltage	36V/43V
Max. Torque	55 Nm (120+/-7 rpm)
Pedal Sensor	Torque and Speed
Q-Factor	135 mm
Chainline	45 mm
Max. Speed	25 km/h
SYSTEM	<2,3 kg
Chainwheel	44T(single) 34/50T(double)

CASSIS PRO ULTEGRA DI2 11



△ FRAME	6061 ALLOY	⊗ REAR SHOCK	-
△ FRAME SIZE	51, 54, 57 CM	⚙ REAR DERAILLEUR	SHIMANO ULTEGRA RD-R8050 DI2
⌒ FORK	6061 ALLOY	⚙ FRONT DERAILLEUR	SHIMANO ULTEGRA FD-R8050 DI2
○ WHEEL SIZE	28"	🔒 BRAKE	SHIMANO ULTEGRA, BR-R8070
⚙ GEARS	22	🔍 TYRE	SCHWALBE 28X700C E-ONE
⚡ SYSTEM	BAFANG	📅 SADDLE	SELLE ROYAL SUPRA
ARTICLE NUMBER	30200860	💡 LIGHT	-
COLOR			

HEAD SET: FSA NO.42B TPR | STEM: ZOOM TDS-D507G-8FOV 90/100/110MM | HANDLE BAR: ZOOM DR-AL-210B 400/420/440MM | GRIP: VELO VLT-079 F | BRAKE LEVER: SHIMANO ULTEGRA DI2 ST-R8070 | BRAKE DISC F/R: SHIMANO SM-RT800 S CL 160M | SHIFTING LEVER: SHIMANO DI2 SW-R9150 | SEAT POST: PROMAX SP-226 | CRANKARM: FSA CK-603 170/175MM | CHAINWHEEL: FSA 50-34T | CASSETTE/COG: SHIMANO CS-HG700-11, 11-SPEED, 11-34T | CHAIN: SHIMANO CN-HG600-11, FOR 11-SPEED | RIM: SHIMANO WH-RS171-700C SET | LOCK: ABUS BATTERY LOCK

Pictures shown here are for illustration purpose only. Actual product may vary due to specification enhancement.

CASSIS 105



△ FRAME	6061 ALLOY	⊗ REAR SHOCK	-
△ FRAME SIZE	51, 54, 57 CM	⚙ REAR DERAILLEUR	SHIMANO 105 RD-R7000
⌒ FORK	6061 ALLOY	⚙ FRONT DERAILLEUR	SHIMANO 105 RD-R7000
○ WHEEL SIZE	28"	⚙ BRAKE	SHIMANO 105 BR-R7070
⚙ GEARS	22	🌀 TYRE	SCHWALBE 28X700C E-ONE
⚡ SYSTEM	BAFANG	📅 SADDLE	SELLE ROYAL SUPRA
ARTICLE NUMBER	30200850	⚙ LIGHT	-
COLOR 30200850A		COLOR 30200850B	

HEAD SET: FSA NO.42B TPR | STEM: ZOOM TDS-D507G-8FOV 90/100/110MM | HANDLE BAR: ZOOM DR-AL-210B 400/420/440MM | GRIP: VELO VLT-079 F | BRAKE LEVER: SHIMANO 105 ST-R7020 | BRAKE DISC F/R: SHIMANO SM-RT70, S 160MM | SHIFTING LEVER: SHIMANO 105 ST-R7020 11S | SEAT POST: PROMAX SP-226 | CRANKARM: FSA CK-603 170/175MM | CHAINWHEEL: FSA 50-34T | CASSETTE/COG: SHIMANO CS-HG700-11, 11-SPEED, 11-34T | CHAIN: SHIMANO CN-HG600-11, FOR 11-SPEED | RIM: SHIMANO WH-RS171-700C SET | LOCK: ABUS AXA BATTERY LOCK

Pictures shown here are for illustration purpose only. Actual product may vary due to specification enhancement.

CASSIS GRAVEL GRX 400



△ FRAME	6061 ALLOY	⊗ REAR SHOCK	-
△ FRAME SIZE		⚙ REAR DERAILLEUR	SHIMANO GRX-400 RD-GRX400
⌒ FORK	6061 ALLOY	⚙ FRONT DERAILLEUR	SHIMANO GRX-400 RD-GRX400
○ WHEEL SIZE	28"	⚙ BRAKE	SHIMANO BR-RX400
⚙ GEARS	20	🌀 TYRE	SCHWALBE G-ONE ALLROUND PERF, RACEGUARD, FOLDING 35-622
⚡ SYSTEM	BAFANG	📅 SADDLE	SELLE ROYAL SETA S1
ARTICLE NUMBER	30200840	⚙ LIGHT	-
COLOR 30200840A			

HEAD SET: FSA NO.42B TPR | STEM: JD-ST58A, 28.6X31.8 EXT: 80-100MM | HANDLE BAR: ZOOM DR-AL-211BT, 470/490/510MM | GRIP: VELO VLT-079 F | BRAKE LEVER: SHIMANO ST-RX400 | BRAKE DISC F/R: SHIMANO SM-RT64, DEORE, S 160MM | SHIFTING LEVER: SHIMANO GRX RX400 ST-RX400R 10S | SEAT POST: KALLOY SPDC1 27,2MM | CRANKARM: FSA CK-603 170/175MM | CHAINWHEEL: FSA 46-34T | CASSETTE/COG: SHIMANO CS-HG500-10, 10-SPD, 11-34T | CHAIN: SHIMANO CN-HG54 SUPER NARROW | RIM: RODI 28" 622X19C ALU, AIRLINE CORSA, 32H | FRONT HUB: SHIMANO FH-RS470 | REAR HUB: SHIMANO HB-RS470 | SPOKE: SAPIM STAINLESS BLACK | LOCK: ABUS AXA BATTERY LOCK

Pictures shown here are for illustration purpose only. Actual product may vary due to specification enhancement.



CITY

PARTNER IN THE CITY

City e-bikes were designed, as the name implies, to meet all conditions of use in the city in a convenient and safe manner. Thanks to the 25 km/h tailwind achievable with the electric assistance, you can easily ride through the city, roll in to your workplace or do the shopping, all these without mentionable physical effort.

CITY E-BIKE

REPTILA 1000+ NEXUS 8C

LOAD CAPACITY UP TO

170
KG

△ FRAME	GEPIDA HYDROFORMING - 6061 ALLOY	⊖ REAR SHOCK	-
△ FRAME SIZE	W: 46, 49, 53, 57CM	⚙ REAR DERAILLEUR	SHIMANO NEXUS 8
⌒ FORK	SUNTOUR CR85 TRAVEL: 63MM	🔧 BRAKE	MAGURA HS-11 + COASTER
○ WHEEL SIZE	28"	🌀 TYRE	SCHWALBE ENERGIZER PLUS 47-622 W/ REFLECTIVE TAPE
⚙ GEARS	8	📉 SADDLE	SELLE ROYAL ESSENZA ACTEX COVER
⚡ SYSTEM	BOSCH	💡 LIGHT	AXA BLUELINE 30 / TRELOCK LS611 6-12V
ARTICLE NUMBER	30201375	COLOR	
	COASTER BRAKE		30201375A
			30201375B

HEADSET: FSA TH807ST THREADED 1 1/8" | STEM: ERGOTEC OCTOPUS XXL EXT: 100MM BB: 31,8MM | HANDLEBAR: ERGOTEC BÜGEL STUTTGARTER W: 610MM BB: 31,8MM | GRIP: VELO VLG-690AD2 | BRAKE LEVER: MAGURA HS-11 | BRAKE DISC F/R: - | SHIFTING LEVER: SHIMANO NEXUS 8 REVOSHIFT SL-C6000 | SEATPOST: ERGOTEC SKALAR 30,9X400 MM | CRANKARM: FSA CK-200 170MM | CHAINWHEEL: FSA 38T STEEL DIRECT MOUNT | CASSETTE/COG: SHIMANO 19T | CHAIN: KMC Z610 XEPT | RIM: RODI VISION 25 622X25C W/ 4D EYELET 36H | FRONT HUB: FORMULA FM21 QR 36H | REAR HUB: SHIMANO NEXUS 8 W/ COASTER SG-C6001-8C 36H | SPOKE: SAPIM STAINLESS 13G BLACK | RACK: MASSLOAD CL-549 | MUDGUARD: SKS 55MM, BLACK STAYS | CHAIN GUARD: HESLING SUPORTIVE V2 | LOCK: ABUS BATTERY LOCK + 4960 | PEDAL: XERAMA SP-811 ALLOY W/ CATEYE | KICKSTAND: STANDWELL SW-RA031J ADJUSTABLE

Pictures shown here are for illustration purpose only. Actual product may vary due to specification enhancement.

REPTILA 1000 DEORE 10











△ FRAME	GEPIDA HYDROFORMING - 6061 ALLOY	⊖ REAR SHOCK	-
△ FRAME SIZE	W: 46, 49, 53, 57CM	⚙ REAR DERAILLEUR	SHIMANO DEORE SHADOW RD-T6000 10S
⌒ FORK	SUNTOUR NEX DS-700C 28" TRAVEL: 63MM	🔧 BRAKE	TEKTRO HD-T275
○ WHEEL SIZE	28"	🌀 TYRE	SCHWALBE ENERGIZER 47-622 W/ REFLECTIVE TAPE
⚙ GEARS	10	📉 SADDLE	SELLE ROYAL ESSENZA ACTEX COVER
⚡ SYSTEM	BOSCH	💡 LIGHT	AXA BLUELINE 30 / TRELOCK LS611 6-12V
ARTICLE NUMBER	30201335	COLOR	
			30201335A
			30201335B
			30201335C

HEADSET: FSA TH807ST THREADED 1 1/8" | STEM: GEPIDA MQ-565 EXT: 85/105MM BB: 25,4MM | HANDLEBAR: GEPIDA NR-AL14 W: 630MM BB: 25,4MM | GRIP: VELO VLG-690AD2 | BRAKE LEVER: TEKTRO HD-M275 | BRAKE DISC F/R: TEKTRO 160MM | SHIFTING LEVER: SHIMANO DEORE SL-M6000 10S | SEATPOST: KALLOY SP-509 30,9X300MM | CRANKARM: FSA CK-200 170MM | CHAINWHEEL: FSA 38T STEEL DIRECT MOUNT | CASSETTE/COG: SHIMANO TIAGRA CS-HG500-10 11-34T 10S | CHAIN: SHIMANO DEORE CN-HG54 10S | RIM: RODI SKORPION CNC 28" 622X19C W/ EYELET 32H | FRONT HUB: FORMULA DC-20LW QR 32H | REAR HUB: FORMULA DC-22W QR 32H | SPOKE: SAPIM STAINLESS BLACK | RACK: MASSLOAD CL-549 | MUDGUARD: SKS 53MM, BLACK STAYS | CHAIN GUARD: HESLING SUPORTIVE V2 | LOCK: ABUS BATTERY LOCK + 4960 | PEDAL: XERAMA SP-811 ALLOY W/ CATEYE | KICKSTAND: STANDWELL SW-RA031J ADJUSTABLE

Pictures shown here are for illustration purpose only. Actual product may vary due to specification enhancement.

REPTILA 1000 NEXUS 8/8C











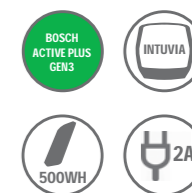

△ FRAME	GEPIDA HYDROFORMING - 6061 ALLOY	⊖ REAR SHOCK	-
△ FRAME SIZE	W: 46, 49, 53, 57CM	⚙️ REAR DERAILLEUR	SHIMANO NEXUS 8
⌒ FORK	SUNTOUR CR85 TRAVEL: 63MM	🔧 BRAKE	MAGURA HS-11/+ COASTER
○ WHEEL SIZE	28"	🌀 TYRE	SCHWALBE ENERGIZER 47-622 W/ REFLECTIVE TAPE
⚙️ GEARS	8	📉 SADDLE	SELLE ROYAL ESSENZA ACTEX COVER
⚡ SYSTEM	BOSCH	💡 LIGHT	AXA BLUELINE 30 / TRELOCK LS611 6-12V
ARTICLE NUMBER	 COASTER BRAKE	COLOR	 30201325A  30201325C
30201325			 30201325B  30201325C
ARTICLE NUMBER		COLOR	 30201355A  30201355C
30201355			 30201355B  30201355C

HEADSET: FSA TH807ST THREADED 1 1/8" | STEM: GEPIDA MQ-565 EXT: 85/105MM BB: 25,4MM | HANDLEBAR: GEPIDA NR-AL14 W: 630MM BB: 25,4MM | GRIP: VELO VLG-690AD2 | BRAKE LEVER: MAGURA HS-11 | BRAKE DISC F/R: - | SHIFTING LEVER: SHIMANO NEXUS 8 REVOSHIFT SL-C6000 | SEATPOST: KALLOY SP-509 30,9X300MM | CRANKARM: FSA CK-200 170MM | CHAINWHEEL: FSA 38T STEEL DIRECT MOUNT | CASSETTE/COG: SHIMANO 19T | CHAIN: KMC Z50 | RIM: RODI SKORPION CNC 28" 622X19C W/ EYELET 32H | FRONT HUB: FORMULA FM21 QR 32H | REAR HUB: SHIMANO NEXUS 8 W/ COASTER SG-C6001-8C 32H | SPOKE: SAPIM STAINLESS BLACK | RACK: MASSLOAD CL-549 | MUDGUARD: SKS 53MM, BLACK STAYS | CHAIN GUARD: HESLING SUPORTIVE V2 | LOCK: ABUS BATTERY LOCK + 4960 | PEDAL: XERAMA SP-811 ALLOY W/ CATEYE | KICKSTAND: STANDWELL SW-RA031J ADJUSTABLE

Pictures shown here are for illustration purpose only. Actual product may vary due to specification enhancement.

REPTILA 900 NEXUS 8/8C



△ FRAME	GEPIDA HYDROFORMING - 6061 ALLOY	⊖ REAR SHOCK	-
△ FRAME SIZE	W: 46, 49CM	⚙️ REAR DERAILLEUR	SHIMANO NEXUS 8
⌒ FORK	SUNTOUR CR85 26" TRAVEL: 50MM	🔧 BRAKE	MAGURA HS-11/+ COASTER
○ WHEEL SIZE	26"	🌀 TYRE	SCHWALBE BIG APPLE 26X2,0 W/ REFLECTIVE TAPE
⚙️ GEARS	8	📉 SADDLE	SELLE ROYAL ESSENZA ACTEX COVER
⚡ SYSTEM	BOSCH	💡 LIGHT	AXA BLUELINE 30 / TRELOCK LS611 6-12V
ARTICLE NUMBER	 COASTER BRAKE	COLOR	 30201315B  30201315C
30201315			 30201315A  30201315C
ARTICLE NUMBER		COLOR	 30201345B  30201345C
30201345			 30201345A  30201345C

HEADSET: FSA TH807ST THREADED 1 1/8" | STEM: GEPIDA MQ-565 EXT: 85/105MM BB: 25,4MM | HANDLEBAR: GEPIDA NR-AL14 W: 630MM BB: 25,4MM | GRIP: VELO VLG-690AD2 | BRAKE LEVER: MAGURA HS-11 | BRAKE DISC F/R: - | SHIFTING LEVER: SHIMANO NEXUS 8 REVOSHIFT SL-C6000 | SEATPOST: KALLOY SP-509 30,9X300MM | CRANKARM: FSA CK-200 170MM | CHAINWHEEL: FSA 38T STEEL DIRECT MOUNT | CASSETTE/COG: SHIMANO 19T | CHAIN: KMC Z50 | RIM: RODI SKORPION CNC 26" 559X19C W/ EYELET 32H | FRONT HUB: FORMULA FM21 QR 32H | REAR HUB: SHIMANO NEXUS 8 W/ COASTER SG-C6001-8C 32H | SPOKE: SAPIM STAINLESS BLACK | RACK: MASSLOAD CL-549 | MUDGUARD: SKS 53MM, BLACK STAYS | CHAIN GUARD: HESLING SUPORTIVE V2 | LOCK: ABUS BATTERY LOCK + 4960 | PEDAL: XERAMA SP-811 ALLOY W/ CATEYE | KICKSTAND: STANDWELL SW-RA031J ADJUSTABLE

Pictures shown here are for illustration purpose only. Actual product may vary due to specification enhancement.

REPTILA 1000 NEXUS 7C



△ FRAME	GEPIDA HYDROFORMING - 6061 ALLOY	⊗ REAR SHOCK	-
△ FRAME SIZE	W: 46, 49, 53, 57CM	⚙ REAR DERAILLEUR	SHIMANO NEXUS 7
└ FORK	SUNTOUR CR85 TRAVEL: 63MM	🔧 BRAKE	MACURA HS-11 + COASTER
○ WHEEL SIZE	28"	🌀 TYRE	SCHWALBE ROAD CRUISER 47-622 REFLECTIVE TAPE
⚙ GEARS	7	📉 SADDLE	SELLE ROYAL ESSENZA ACTEX COVER
⚡ SYSTEM	BOSCH	💡 LIGHT	AXA BLUELINE 30 / TRELOCK LS611 6-12V
ARTICLE NUMBER	30201305	COLOR	

HEADSET: FSA TH807ST THREADED 1 1/8" | STEM: GEPIDA MQ-565 EXT: 85/105MM BB: 25,4MM | HANDLEBAR: GEPIDA NR-AL14 W: 630MM BB: 25,4MM | GRIP: VELO VLG-690AD2 | BRAKE LEVER: MACURA HS-11 | BRAKE DISC F/R: - | SHIFTING LEVER: SHIMANO NEXUS 7 REVOSHIFT SL-C3000 | SEATPOST: KALLOY SP-509 30,9X300MM | CRANKARM: FSA CK-200 170MM | CHAINWHEEL: FSA 38T STEEL DIRECT MOUNT | CASSETTE/COG: SHIMANO 19T | CHAIN: KMC Z50 | RIM: RODI SKORPION CNC 28" 622X19C W/ EYELET 32H | FRONT HUB: FORMULA FM21 QR 32H | REAR HUB: SHIMANO NEXUS 7 W/ COASTER SG-C3001-7C 32H | SPOKE: SAPIM STAINLESS | RACK: STANDWELL SW-EA410 | MUDGUARD: SKS 53MM, BLACK STAYS | CHAIN GUARD: HESLING SUPORTIVE V2 | LOCK: ABUS BATTERY LOCK | PEDAL: XERAMA SP-811 ALLOY W/ CATEYE | KICKSTAND: STANDWELL SW-RA031J ADJUSTABLE

Pictures shown here are for illustration purpose only. Actual product may vary due to specification enhancement.

REPTILA 800 ALTUS 7

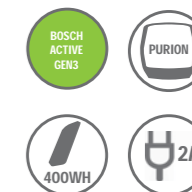

△ FRAME	GEPIDA HYDROFORMING - 6061 ALLOY	⊗ REAR SHOCK	-
△ FRAME SIZE	W: 46, 49CM	⚙ REAR DERAILLEUR	SHIMANO ALTUS RD-M310DL 7S
└ FORK	RIGID STEEL FORK	🔧 BRAKE	TEKTRO HD-M275
○ WHEEL SIZE	26"	🌀 TYRE	SCHWALBE BIG APPLE 26X2,0 W/ REFLECTIVE TAPE
⚙ GEARS	7	📉 SADDLE	SELLE ROYAL ALPINE DRC
⚡ SYSTEM	BOSCH	💡 LIGHT	AXA BLUELINE 30 / TRELOCK LS611 6-12V
ARTICLE NUMBER	30201385	COLOR	

HEADSET: FSA NO.11N | STEM: KALLOY AS601 BB: 25,4MM EXT: 90MM 15DEG | HANDLEBAR: GEPIDA STEEL 155TP 640MM RIZER BB: 25,4MM | GRIP: VELO VLG-690AD2 | BRAKE LEVER: TEKTRO HD-T275 | BRAKE DISC F/R: TEKTRO 160/160MM | SHIFTING LEVER: SHIMANO TY SL-RS35 REVOSHIFT 7S | SEATPOST: ZOOM SP-C207 30,9X300MM | CRANKARM: FSA CK-200 170MM | CHAINWHEEL: FSA 38T STEEL DIRECT MOUNT | CASSETTE/COG: SHIMANO CS-HG200-7 12-32 7S | CHAIN: KMC Z50 | RIM: BERETTA DISC25 28" 622X19C | FRONT HUB: FORMULA DC-20 QR 32H | REAR HUB: FORMULA DC-22 QR 32H | SPOKE: SAPIM STAINLESS STEEL BLACK | RACK: MASSLOAD CL-549 | MUDGUARD: ORION BLACK | CHAIN GUARD: HESLING SUPORTIVE V2 | LOCK: ABUS BATTERY LOCK | PEDAL: XERAMA SP-807 PP BODY W/ CATEYE | KICKSTAND: STANDWELL SW-RA031J ADJUSTABLE

Pictures shown here are for illustration purpose only. Actual product may vary due to specification enhancement.

REPTILA 800 ALTUS 7



△ FRAME	GEPIDA HYDROFORMING - 6061 ALLOY		⊗ REAR SHOCK	-	
△ FRAME SIZE	W: 46, 49, 53, 57CM		⚙ REAR DERAILLEUR	SHIMANO ALTUS RD-M310DL 7S	
— FORK	RIGID STEEL FORK		🔧 BRAKE	TEKTRO HD-M275	
○ WHEEL SIZE	28"		🌀 TYRE	SCHWALBE ENERGIZER 47-622 W/ REFLECTIVE TAPE	
⚙ GEARS	7		📜 SADDLE	SELLE ROYAL ALPINE DRC	
⚡ SYSTEM	BOSCH		💡 LIGHT	AXA BLUELINE 30 / TRELOCK LS611 6-12V	
ARTICLE NUMBER	COLOR	30201395A	30201395C		
30201395		30201395B	30201395D		

HEADSET: FSA NO.11N | STEM: KALLOY AS601 BB: 25,4MM EXT: 90MM 15DEG | HANDLEBAR: GEPIDA STEEL 155TP 640MM RIZER BB: 25,4MM | GRIP: VELO VLG-690AD2 | BRAKE LEVER: TEKTRO HD-T275 | BRAKE DISC F/R: TEKTRO 160/160MM | SHIFTING LEVER: SHIMANO TY SL-RS35 REVOSHIFT 7S | SEATPOST: ZOOM SP-C207 30,9X300MM | CRANKARM: FSA CK-200 170MM | CHAINWHEEL: FSA 38T STEEL DIRECT MOUNT | CASSETTE/COG: SHIMANO CS-HG200-7 12-32 7S | CHAIN: KMC Z50 | RIM: BERETTA DISC25 28" 622X19C | FRONT HUB: FORMULA DC-20 QR 32H | REAR HUB: FORMULA DC-22 QR 32H | SPOKE: SAPIM STAINLESS STEEL BLACK | RACK: MASSLOAD CL-549 | MUDGUARD: ORION BLACK | CHAIN GUARD: HESLING SUPORTIVE V2 | LOCK: ABUS BATTERY LOCK | PEDAL: XERAMA SP-807 PP BODY W/ CATEYE | KICKSTAND: STANDWELL SW-RA031J ADJUSTABLE

Pictures shown here are for illustration purpose only. Actual product may vary due to specification enhancement.

REPTILA 1000 NEXUS 7C RT



△ FRAME	GEPIDA HYDROFORMING - 6061 ALLOY		⊗ REAR SHOCK	-	
△ FRAME SIZE	W: 46, 49, 53, 57CM		⚙ REAR DERAILLEUR	SHIMANO NEXUS 7	
— FORK	SUNTOUR CR85 TRAVEL: 63MM		🔧 BRAKE	MAGURA HS-11 + COASTER	
○ WHEEL SIZE	28"		🌀 TYRE	SCHWALBE ROAD CRUISER 47-622 REFLECTIVE	
⚙ GEARS	7		📜 SADDLE	SELLE ROYAL ESSENZA ACTEX COVER	
⚡ SYSTEM	BOSCH		💡 LIGHT	AXA BLUELINE 30 / TRELOCK LS611 6-12V	
ARTICLE NUMBER	COLOR	30201905A	30201905B		
30201905		30201905A	30201905C		

HEADSET: FSA TH807ST THREADED 1 1/8" | STEM: GEPIDA MQ-565 EXT: 85/105MM BB: 25,4MM | HANDLEBAR: GEPIDA NR-14 STEEL W: 630MM BB: 25,4MM | GRIP: VELO VLG-690AD2 | BRAKE LEVER: MAGURA HS-11 | BRAKE DISC F/R: - | SHIFTING LEVER: SHIMANO NEXUS 7 REVOSHIFT SL-C3000 | SEATPOST: KALLOY SP-509 27,2X300MM | CRANKARM: FSA CK-200 170MM | CHAINWHEEL: FSA 38T STEEL DIRECT MOUNT | CASSETTE/COG: SHIMANO 19T | CHAIN: KMC Z50 | RIM: RODI SKORPION CNC 28" 622X19C W/ EYELET 32H | FRONT HUB: FORMULA FM21 QR 32H | REAR HUB: SHIMANO NEXUS 7 W/ COASTER SG-C3001-7C 32H | SPOKE: SAPIM STAINLESS | RACK: STANDWELL SW-EA410 | MUDGUARD: SKS 53MM, BLACK STAYS | CHAIN GUARD: HESLING SUPORTIVE V2 | LOCK: ABUS BATTERY LOCK | PEDAL: XERAMA SP-811 ALLOY W/ CATEYE | KICKSTAND: STANDWELL SW-RA031J ADJUSTABLE

Pictures shown here are for illustration purpose only. Actual product may vary due to specification enhancement.

REPTILA 1000 NEXUS 7 RT



△ FRAME	GEPIDA HYDROFORMING - 6061 ALLOY	⊗ REAR SHOCK	-
△ FRAME SIZE	W: 46, 49, 53, 57CM	⚙ REAR DERAILLEUR	SHIMANO NEXUS 7
⌒ FORK	SUNTOUR CR85 TRAVEL: 63MM	🔧 BRAKE	MAGURA HS-11
○ WHEEL SIZE	28"	🌀 TYRE	SCHWALBE ROAD CRUISER 47-622 REFLECTIVE
⚙ GEARS	7	📵 SADDLE	SELLE ROYAL ESSENZA ACTEX COVER
⚡ SYSTEM	BOSCH	💡 LIGHT	AXA BLUELINE 30 / TRELOCK LS611 6-12V
ARTICLE NUMBER		COLOR	
30201985		30201985B	
		30201985A	30201985C

HEADSET: FSA TH807ST THREADED 1 1/8" | STEM: CEPIDA MQ-565 EXT: 85/105MM BB: 25,4MM | HANDLEBAR: CEPIDA NR-14 STEEL W: 630MM BB: 25,4MM | GRIP: VELO VLC-690AD2 | BRAKE LEVER: MAGURA HS-11 | BRAKE DISC F/R: - | SHIFTING LEVER: SHIMANO NEXUS 7 REVOSHIFT SL-C3000 | SEATPOST: KALLOY SP-509 27,2X300MM | CRANKARM: FSA CK-200 170MM | CHAINWHEEL: FSA 38T STEEL DIRECT MOUNT | CASSETTE/COG: SHIMANO 19T | CHAIN: KMC Z50 | RIM: RODI SKORPION CNC 28" 622X19C W/ EYELET 32H | FRONT HUB: FORMULA FM21 QR 32H | REAR HUB: SHIMANO NEXUS 7 W/ COASTER SG-C3001-7C 32H | SPOKE: SAPIM STAINLESS | RACK: STANDWELL SW-EA410 | MUDGUARD: SKS 53MM, BLACK STAYS | CHAIN GUARD: HESLING SUPORTIVE V2 | LOCK: ABUS BATTERY LOCK | PEDAL: XERAMA SP-811 ALLOY W/ CATEYE | KICKSTAND: STANDWELL SW-RA031J ADJUSTABLE

Pictures shown here are for illustration purpose only. Actual product may vary due to specification enhancement.

CRISIA NEXUS 7C BAF-M



△ FRAME	GEPIDA HYDROFORMING - 6061 ALLOY	⊗ REAR SHOCK	-
△ FRAME SIZE	W: 46, 49, 53CM	⚙ REAR DERAILLEUR	SHIMANO NEXUS 7
⌒ FORK	SUNTOUR CR7V 700C 40MM	🔧 BRAKE	SHIMANO ALIVIO BR-T4000 + COASTER BRAKE
○ WHEEL SIZE	28"	🌀 TYRE	WTB/FREEDOM WEDGE 700X47C W/ REFLECTIVE TAPE
⚙ GEARS	7	📵 SADDLE	SELLE ROYAL ESSENZA ACTEX COVER
⚡ SYSTEM	BAFANG	💡 LIGHT	AXA ECHO 15 / TRELOCK LS611 6-12V
ARTICLE NUMBER		COLOR	
30200935		30200935A	30200935B

HEADSET: FSA TH807ST THREADED 1 1/8" | STEM: CEPIDA MQ-565 EXT: 85/105 MM | HANDLEBAR: CEPIDA NR-14 STEEL W: 630MM BB: 25,4MM | GRIP: VELO VLC-690AD2 | BRAKE LEVER: CEPIDA LM-48 | BRAKE DISC F/R: - | SHIFTING LEVER: SHIMANO NEXUS 7 REVOSHIFT SL-C3000 | SEATPOST: CEPIDA ALLOY, 27,2X300 MM | CRANKARM: PROWHEEL 170MM | CHAINWHEEL: BAFANG 38T STEEL | CASSETTE/COG: STURMEY ARCHER 19T | CHAIN: KMC Z50 | RIM: BERETTA MT-240 28" 32H | FRONT HUB: FORMULA FM21 NT 32H | REAR HUB: SHIMANO NEXUS 7 W/ COASTER SG-C3001-7C 32H | SPOKE: SAPIM STAINLESS BLACK | RACK: CEPIDA ALLOY | MUDGUARD: ORION | CHAIN GUARD: HERRMANS HALO 38T | LOCK: AXA BATTERY LOCK | PEDAL: XERAMA SP-807 | KICKSTAND: STANDWELL SW-RA031J ADJUSTABLE

Pictures shown here are for illustration purpose only. Actual product may vary due to specification enhancement.

CRISIA ALTUS 7 BAF-M



△ FRAME	CEPIDA HYDROFORMING - 6061 ALLOY	⊗ REAR SHOCK	-
△ FRAME SIZE	W: 46, 49, 53CM	⚙ REAR DERAILLEUR	SHIMANO ALTUS RD-M310DL 7S
⌒ FORK	SUNTOUR CR7V 700C 40MM	🔧 BRAKE	SHIMANO ALIVIO BR-T4000
○ WHEEL SIZE	28"	🌀 TYRE	WTB/FREEDOM WEDGE 700X47C W/ REFLECTIVE TAPE
⚙ GEARS	7	🚽 SADDLE	SELLE ROYAL ESSENZA ACTEX COVER
🔌 SYSTEM	BAFANG	💡 LIGHT	AXA ECHO 15 / TRELOCK LS611 6-12V

ARTICLE NUMBER

30200915

COLOR



HEADSET: FSA TH807ST THREADED 1 1/8" | STEM: CEPIDA MQ-565 EXT: 85/105 MM | HANDLEBAR: CEPIDA NR-14 STEEL W: 630MM BB: 25,4MM | GRIP: VELO VLG-690AD2 | BRAKE LEVER: CEPIDA LM-48 | BRAKE DISC F/R: - | SHIFTING LEVER: SHIMANO REVOSHIFT SL-RS35 | SEATPOST: CEPIDA ALLOY, 27,2X300 MM | CRANKARM: PROWHEEL 170MM | CHAINWHEEL: BAFANG 38T STEEL | CASSETTE/COG: STURMEY ARCHER 19T | CHAIN: KMC Z50 | RIM: BERETTA MT-240 28" 32H | FRONT HUB: FORMULA FM21 NT 32H | REAR HUB: FORMULA FM31 NT 32H | SPOKE: SAPIM STAINLESS BLACK | RACK: CEPIDA ALLOY | MUDGUARD: ORION | CHAIN GUARD: HERRMANS HALO 38T | LOCK: AXA BATTERY LOCK | PEDAL: XERAMA SP-807 | KICKSTAND: STANDWELL SW-RA031J ADJUSTABLE

Pictures shown here are for illustration purpose only. Actual product may vary due to specification enhancement.

CRISIA ALTUS 7 BAF-F

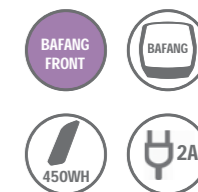

△ FRAME	CEPIDA HYDROFORMING - 6061 ALLOY	⊗ REAR SHOCK	-
△ FRAME SIZE	W: 46, 49, 53CM	⚙ REAR DERAILLEUR	SHIMANO ALTUS RD-M310DL 7S
⌒ FORK	SUNTOUR CR7V 700C 40MM	🔧 BRAKE	SHIMANO ALIVIO BR-T4000
○ WHEEL SIZE	28"	🌀 TYRE	WTB/FREEDOM WEDGE 700X47C W/ REFLECTIVE TAPE
⚙ GEARS	7	🚽 SADDLE	SELLE ROYAL ESSENZA ACTEX COVER
🔌 SYSTEM	BAFANG	💡 LIGHT	AXA ECHO 15 / TRELOCK LS611 6-12V

ARTICLE NUMBER

30200965

COLOR



HEADSET: FSA TH807ST THREADED 1 1/8" | STEM: CEPIDA MQ-565 EXT: 85/105 MM | HANDLEBAR: CEPIDA NR-14 STEEL W: 630MM BB: 25,4MM | GRIP: VELO VLG-690AD2 | BRAKE LEVER: CEPIDA LM-48 | BRAKE DISC F/R: - | SHIFTING LEVER: SHIMANO REVOSHIFT SL-RS35 | SEATPOST: CEPIDA ALLOY, 27,2X300 MM | CRANKARM: PROWHEEL PRO-A38 38T 170MM | CHAINWHEEL: 38T STEEL | CASSETTE/COG: SHIMANO MF-TZ500 14-28T 7S | CHAIN: KMC Z50 | RIM: RODI WEB 28" 36H / BERETTA MT-240 28" 36H | FRONT HUB: BAFANG FRONT MOTOR FM.G320 | REAR HUB: FORMULA FM31 NT 32H | SPOKE: SAPIM STAINLESS | RACK: CEPIDA ALLOY | MUDGUARD: ORION | CHAIN GUARD: HERRMANS HALO 38T | LOCK: AXA BATTERY LOCK | PEDAL: XERAMA SP-811 ALLOY W/ CATEYE | KICKSTAND: STANDWELL SW-MA008 ADJUSTABLE

Pictures shown here are for illustration purpose only. Actual product may vary due to specification enhancement.



TREKKING

ADVENTURE WITHOUT LIMITS

Our trekking e-bikes are designed to overcome thousands of kilometres with an engine specially designed for this segment, the essence of which is raw force and power. It supports performance harmoniously, be it an uphill climb or a flat ground. Long distances can be covered thanks to the batteries of greater capacity. There are no more limits, reach for the stars!

TREKKING E-BIKE

FASTIDA PRO XT 10

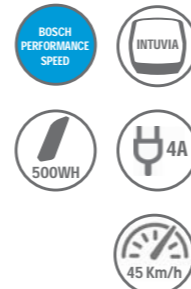

△ FRAME	GEPIDA GRAVITY CASTING - 6061 ALLOY	⊗ REAR SHOCK	-
△ FRAME SIZE	M: 52, 56CM	⚙ REAR DERAILLEUR	SHIMANO XT RD-T8000 SHADOW
⌒ FORK	SUNTOUR XCM32 LO 29" 15QLC TRAVEL: 80MM	🔧 BRAKE	MAGURA BR-MT4E
○ WHEEL SIZE	28"	🌀 TYRE	SCHWALBE ENERGIZER PLUS W/ REFELCTIVE TAPE 40-622
⚙ GEARS	10	📵 SADDLE	SELLE ROYAL ARIEL GEL HRC ACTEX COVER
⚡ SYSTEM	BOSCH	💡 LIGHT	SPANNINGA AXENDO 100 / FLEXIO SP W/ BRAKE LIGHT FUNCTION

ARTICLE NUMBER
30202270

COLOR



HEADSET: FSA NO.42B-1 | STEM: TRANZX JDST-58A EXT: 90/100MM | HANDLEBAR: PROMAX HB-3188 RIZER 640MM BB: 31,8MM | GRIP: VELO VLG-649AD2S W/ CLAMP | BRAKE LEVER: MAGURA BL-MT4E BALL END | BRAKE DISC F/R: MAGURA STORM 180MM | SHIFTING LEVER: SHIMANO DEORE SL-T6000 10S | SEATPOST: KALLOY SPDC1 30,9X300MM | CRANKARM: FSA CK-745 175MM | CHAINWHEEL: FSA 18T STEEL | CASSETTE/COG: SHIMANO TIAGRA CS-HG500-10 11-34T 10S | CHAIN: SHIMANO DEORE CN-HG54 10S | RIM: RODI BLACKROCK 28" 622X21C 32H | FRONT HUB: SHIMANO DEORE HB-M6010 QR15 32H | REAR HUB: SHIMANO DEORE FH-M6010 X12 32H | SPOKE: SAPIM STAINLESS BLACK 13G | MUDGUARD: SKS 53MM, BLACK STAYS | CHAIN GUARD: INTEGRATED CHAINGUARD | LOCK: ABUS BATTERY LOCK | PEDAL: XERAMA SP-811 ALLOY W/ CATEYE | RACK: MASSLOAD CL 905A | KICKSTAND: PLETSCHER COMP ARA F13

Pictures shown here are for illustration purpose only. Actual product may vary due to specification enhancement.

FASTIDA XT 10

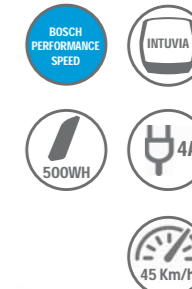

△ FRAME	GEPIDA SPECIAL HYDROFORMING - 6061 ALLOY	⊗ REAR SHOCK	-
△ FRAME SIZE	M: 52, 56CM	⚙ REAR DERAILLEUR	SHIMANO XT RD-T8000 SHADOW
⌒ FORK	SUNTOUR XCM32 LO 29" 15QLC TRAVEL: 80MM	🔧 BRAKE	MAGURA BR-MT4E
○ WHEEL SIZE	28"	🌀 TYRE	SCHWALBE ENERGIZER PLUS W/ REFELCTIVE TAPE 40-622
⚙ GEARS	10	📵 SADDLE	SELLE ROYAL ARIEL GEL HRC ACTEX COVER
⚡ SYSTEM	BOSCH	💡 LIGHT	SPANNINGA AXENDO 100 / FLEXIO SP W/ BRAKE LIGHT FUNCTION

ARTICLE NUMBER
30202260

COLOR



HEADSET: FSA NO.11N | STEM: TRANZX JDST-58A EXT: 90/100MM | HANDLEBAR: PROMAX HB-3188 RIZER 640MM BB: 31,8MM | GRIP: VELO VLG-649AD2S W/ CLAMP | BRAKE LEVER: MAGURA BL-MT4E BALL END | BRAKE DISC F/R: MAGURA STORM 180MM | SHIFTING LEVER: SHIMANO DEORE SL-T6000 10S | SEATPOST: KALLOY SPDC1 27,2X300MM | CRANKARM: FSA CK-745 175MM | CHAINWHEEL: FSA 18T STEEL | CASSETTE/COG: SHIMANO TIAGRA CS-HG500-10 11-34T 10S | CHAIN: SHIMANO DEORE CN-HG54 10S | RIM: RODI BLACKROCK 28" 622X21C 32H | FRONT HUB: SHIMANO DEORE HB-M6010 QR15 32H | REAR HUB: SHIMANO DEORE FH-M6000 QR 32H | SPOKE: SAPIM STAINLESS BLACK 13G | RACK: MASSLOAD CL 905A | MUDGUARD: SKS 53MM, BLACK STAYS | CHAIN GUARD: INTEGRATED CHAINGUARD | LOCK: ABUS BATTERY LOCK | PEDAL: XERAMA SP-811 ALLOY W/ CATEYE | KICKSTAND: PLETSCHER COMP ARA F13

Pictures shown here are for illustration purpose only. Actual product may vary due to specification enhancement.

ALBOIN PRO XT 10



△ FRAME	GEPIDA GRAVITY CASTING - 6061 ALLOY	⊗ REAR SHOCK	-
△ FRAME SIZE	M: 52, 56CM	⚙ REAR DERAILLEUR	SHIMANO XT SHADOW RD-M781 10S
⌒ FORK	SUNTOUR NEX-E25 700C DS TPR TRAVEL: 63MM QR15	🔧 BRAKE	SHIMANO DEORE BR-M6000
○ WHEEL SIZE	28"	🌀 TYRE	SCHWALBE ENERGIZER+ 47-622 W/ REFLECTIVE TAPE
⚙ GEARS	10	📉 SADDLE	SELLE ROYAL ARIEL GEL HRC ACTEX COVER
⚡ SYSTEM	BOSCH	💡 LIGHT	TRELOCK AIRFLOW 70 / TRELOCK LS611 6-12V

ARTICLE NUMBER

30202280

COLOR



HEADSET: FSA NO.42B | STEM: TRANZX JDST-58A EXT: 90MM | HANDLEBAR: PROMAX HB-3188 RIZER 640MM BB: 31,8MM | GRIP: VELO VLG-775-12D2 + VLP-171 | BRAKE LEVER: SHIMANO DEORE BL-T6000 | BRAKE DISC F/R: SHIMANO DEORE RT-56 180/160MM | SHIFTING LEVER: SHIMANO DEORE SL-T6000 10S | SEATPOST: KALLOY SPDC1 30,9X400MM | CRANKARM: FSA CK-745 175MM | CHAINWHEEL: FSA 18T STEEL | CASSETTE/COG: SHIMANO TIAGRA CS-HG500-10 11-34T 10S | CHAIN: SHIMANO DEORE CN-HG54 10S | RIM: RODI BLACKROCK 28" 622X21C EYELET, 32H | FRONT HUB: SHIMANO DEORE HB-M6010 QR15 32H | REAR HUB: SHIMANO DEORE FH-M6010 X12 32H | SPOKE: SAPIM STAINLESS BLACK | MUDGUARD: SKS 53MM, BLACK STAYS | CHAIN GUARD: INTEGRATED CHAINGUARD | LOCK: ABUS BATTERY LOCK | PEDAL: XERAMA SP-811 ALLOY W/ CATEYE | KICKSTAND: HEBIE 668M1 18MM | RACK: GEPIDA ALLOY | KICKSTAND: STANDWELL SW-RA031J ADJUSTABLE

Pictures shown here are for illustration purpose only. Actual product may vary due to specification enhancement.

ALBOIN PRO LS XT 10



△ FRAME	GEPIDA GRAVITY CASTING - 6061 ALLOY	⊗ REAR SHOCK	-
△ FRAME SIZE	L: 44, 48, 52CM	⚙ REAR DERAILLEUR	SHIMANO XT SHADOW RD-M781 10S
⌒ FORK	SUNTOUR NEX-E25 700C DS TPR TRAVEL: 63MM QR15	🔧 BRAKE	SHIMANO DEORE BR-M6000
○ WHEEL SIZE	28"	🌀 TYRE	SCHWALBE ENERGIZER+ 47-622 W/ REFLECTIVE TAPE
⚙ GEARS	10	📉 SADDLE	SELLE ROYAL ARIEL GEL HRC ACTEX COVER
⚡ SYSTEM	BOSCH	💡 LIGHT	TRELOCK AIRFLOW 70 / TRELOCK LS611 6-12V

ARTICLE NUMBER

30202286

COLOR



HEADSET: FSA NO.42B | STEM: TRANZX JDST-58A EXT: 90MM | HANDLEBAR: PROMAX HB-3188 RIZER 640MM BB: 31,8MM | GRIP: VELO VLG-775-12D2 + VLP-171 | BRAKE LEVER: SHIMANO DEORE BL-T6000 | BRAKE DISC F/R: SHIMANO DEORE RT-56 180/160MM | SHIFTING LEVER: SHIMANO DEORE SL-T6000 10S | SEATPOST: KALLOY SPDC1 30,9X400MM | CRANKARM: FSA CK-745 175MM | CHAINWHEEL: FSA 18T STEEL | CASSETTE/COG: SHIMANO TIAGRA CS-HG500-10 11-34T 10S | CHAIN: SHIMANO DEORE CN-HG54 10S | RIM: RODI BLACKROCK 28" 622X21C EYELET, 32H | FRONT HUB: SHIMANO DEORE HB-M6010 QR15 32H | REAR HUB: SHIMANO DEORE FH-M6010 X12 32H | SPOKE: SAPIM STAINLESS BLACK | MUDGUARD: SKS 53MM, BLACK STAYS | CHAIN GUARD: INTEGRATED CHAINGUARD | LOCK: ABUS BATTERY LOCK | PEDAL: XERAMA SP-811 ALLOY W/ CATEYE | KICKSTAND: HEBIE 668M1 18MM | RACK: GEPIDA ALLOY | KICKSTAND: STANDWELL SW-RA031J ADJUSTABLE

Pictures shown here are for illustration purpose only. Actual product may vary due to specification enhancement.

ALBOIN CURVE ALFINE 8



△ FRAME	GEPIDA HYDROFORMING - 6061 ALLOY	⊗ REAR SHOCK	-
△ FRAME SIZE	52, 56 CM	⚙ REAR DERAILLEUR	SHIMANO ALFINE 8
⌒ FORK	SUNTOUR NEX-E25 700C DS TRAVEL: 63MM	🔧 BRAKE	SHIMANO DEORE BR-M6000
○ WHEEL SIZE	28"	🌀 TYRE	SCHWALBE ENERGIZER 47-622 W/ REFLECTIVE TAPE
⚙ GEARS	8	📅 SADDLE	SELLE ROYAL ARIEL GEL HRC ACTEX COVER
⚡ SYSTEM	BOSCH	💡 LIGHT	AXA BLUELINE 30 / TRELOCK LS611 6-12V

ARTICLE NUMBER
30202250

COLOR



HEAD SET: FSA NO.11N | STEM: GEPIDA TDS-299N ADJUSTABLE EXT: 105MM | HANDLE BAR: PROMAX HB-3188 RIZER 640MM BB: 31,8MM | GRIP: VELO VLG-775-12D2 + VLP-171 | BRAKE LEVER: SHIMANO DEORE BL-T6000 | BRAKE: SHIMANO DEORE BR-M6000 | BRAKE DISC F/R: SHIMANO DEORE RT-54S 160MM | SHIFTING LEVER: SHIMANO ALFINE 8 SL-S7000-8 | SEAT POST: KALLOY SPDC1 27,2X300MM | CRANKARM: FSA CK-602 175MM | CHAINWHEEL: FSA 44T STEEL | CASSETTE/COG: SHIMANO 19T | CHAIN: KMC Z610 XEPT | CHAIN GUARD: HESLING SUPORTIVE V2 | RIM: RODI BLACKROCK 28" 622X21C EYELET, 32H | FRONT HUB: SHIMANO ALIVIO HB-M4050 QR 32H | REAR HUB: SHIMANO ALFINE 8 SG-S7000-8 32H | SPOKE: SAPIM STAINLESS BLACK | RACK: MASSLOAD CL 905A | MUDGUARD: SKS 53MM, BLACK STAYS | PEDAL: XERAMA SP-811 ALLOY W/ CATEYE | LOCK: ABUS BATTERY LOCK | KICKSTAND: STANDWELL SW-RA031J 18MM

Pictures shown here are for illustration purpose only. Actual product may vary due to specification enhancement.

ALBOIN CURVE LS ALFINE 8



△ FRAME	GEPIDA HYDROFORMING - 6061 ALLOY	⊗ REAR SHOCK	-
△ FRAME SIZE	44, 48, 52, CM	⚙ REAR DERAILLEUR	SHIMANO ALFINE 8
⌒ FORK	SUNTOUR NEX-E25 700C DS TRAVEL: 63MM	🔧 BRAKE	SHIMANO DEORE BR-M6000
○ WHEEL SIZE	28"	🌀 TYRE	SCHWALBE ENERGIZER 47-622 W/ REFLECTIVE TAPE
⚙ GEARS	8	📅 SADDLE	SELLE ROYAL ARIEL GEL HRC ACTEX COVER
⚡ SYSTEM	BOSCH	💡 LIGHT	AXA BLUELINE 30 / TRELOCK LS611 6-12V

ARTICLE NUMBER
30202256

COLOR









HEAD SET: FSA NO.11N | STEM: GEPIDA TDS-299N ADJUSTABLE EXT: 105MM | HANDLE BAR: PROMAX HB-3188 RIZER 640MM BB: 31,8MM | GRIP: VELO VLG-775-12D2 + VLP-171 | BRAKE LEVER: SHIMANO DEORE BL-T6000 | BRAKE: SHIMANO DEORE BR-M6000 | BRAKE DISC F/R: SHIMANO DEORE RT-54S 160MM | SHIFTING LEVER: SHIMANO ALFINE 8 SL-S7000-8 | SEAT POST: KALLOY SPDC1 27,2X300MM | CRANKARM: FSA CK-602 175MM | CHAINWHEEL: FSA 44T STEEL | CASSETTE/COG: SHIMANO 19T | CHAIN: KMC Z610 XEPT | CHAIN GUARD: HESLING SUPORTIVE V2 | RIM: RODI BLACKROCK 28" 622X21C EYELET, 32H | FRONT HUB: SHIMANO ALIVIO HB-M4050 QR 32H | REAR HUB: SHIMANO ALFINE 8 SG-S7000-8 32H | SPOKE: SAPIM STAINLESS BLACK | RACK: MASSLOAD CL 905A | MUDGUARD: SKS 53MM, BLACK STAYS | PEDAL: XERAMA SP-811 ALLOY W/ CATEYE | LOCK: ABUS BATTERY LOCK | KICKSTAND: STANDWELL SW-RA031J 18MM

Pictures shown here are for illustration purpose only. Actual product may vary due to specification enhancement.

ALBOIN CURVE DEORE 10









△ FRAME	GEPIDA HYDROFORMING - 6061 ALLOY	⊗ REAR SHOCK	-
△ FRAME SIZE	52, 56 CM	⚙ REAR DERAILLEUR	SHIMANO DEORE RD-T6000 10S
⌒ FORK	SUNTOUR NEX-E25 700C DS TRAVEL: 63MM	🔧 BRAKE	SHIMANO DEORE BR-M6000
○ WHEEL SIZE	28"	🌀 TYRE	SCHWALBE ENERGIZER 47-622 W/ REFLECTIVE TAPE
⚙ GEARS	10	📉 SADDLE	SELLE ROYAL ARIEL GEL HRC ACTEX COVER
⚡ SYSTEM	BOSCH	💡 LIGHT	AXA BLUELINE 30 / TRELOCK LS611 6-12V
ARTICLE NUMBER	COLOR		
30201290	   30201290A	   30201290B	

HEAD SET: FSA NO.11N | STEM: GEPIDA TDS-299N ADJUSTABLE EXT: 105MM | HANDLE BAR: PROMAX HB-3188 BB: 31,8MM W: 640MM RISE:30MM | GRIP: VELO VLG-775-12D2 + VLP-171 | BRAKE LEVER: SHIMANO DEORE BL-T6000 | BRAKE: SHIMANO DEORE BR-M6000 | BRAKE DISC F/R: SHIMANO DEORE RT-56S 160MM | SHIFTING LEVER: SHIMANO DEORE SL-T6000 10S | SEAT POST: KALLOY SPDC1 27,2X300MM SBB | CRANKARM: FSA CK-602 175MM | CHAINWHEEL: FSA 44T STEEL | CASSETTE/COG: SHIMANO TIAGRA CS-HG500-10 11-34T | CHAIN: SHIMANO DEORE CN-HG54 10S | CHAIN GUARD: HESLING SUPORTIVE V2 | RIM: RODI BLACKROCK 28" BLACK | FRONT HUB: FORMULA DC-20LW QR 32H | REAR HUB: FORMULA DC-22LW QR 32H | SPOKE: SAPIM BLACK | RACK: MASSLOAD CL-905A | MUDGUARD: SKS 53MM, BLACK STAYS | LOCK: ABUS BATTERY LOCK | PEDAL: XERAMA SP-810 ALLOY W/ CATEYE | KICKSTAND: STANDWELL SW-RA031J 40MM

Pictures shown here are for illustration purpose only. Actual product may vary due to specification enhancement.

ALBOIN CURVE LS DEORE 10



△ FRAME	GEPIDA HYDROFORMING - 6061 ALLOY	⊗ REAR SHOCK	-
△ FRAME SIZE	44, 48, 52 CM	⚙ REAR DERAILLEUR	SHIMANO DEORE RD-T6000 10S
⌒ FORK	SUNTOUR NEX-E25 700C DS TRAVEL: 63MM	🔧 BRAKE	SHIMANO DEORE BR-M6000
○ WHEEL SIZE	28"	🌀 TYRE	SCHWALBE ENERGIZER 47-622 W/ REFLECTIVE TAPE
⚙ GEARS	10	📉 SADDLE	SELLE ROYAL ARIEL GEL HRC ACTEX COVER
⚡ SYSTEM	BOSCH	💡 LIGHT	AXA BLUELINE 30 / TRELOCK LS611 6-12V
ARTICLE NUMBER	COLOR		
30201296	   30201296A	   30201296B	

HEAD SET: FSA NO.11N | STEM: GEPIDA TDS-299N ADJUSTABLE EXT: 105MM | HANDLE BAR: PROMAX HB-3188 BB: 31,8MM W: 640MM RISE:30MM | GRIP: VELO VLG-775-12D2 + VLP-171 | BRAKE LEVER: SHIMANO DEORE BL-T6000 | BRAKE: SHIMANO DEORE BR-M6000 | BRAKE DISC F/R: SHIMANO DEORE RT-56S 160MM | SHIFTING LEVER: SHIMANO DEORE SL-T6000 10S | SEAT POST: KALLOY SPDC1 27,2X300MM SBB | CRANKARM: FSA CK-602 175MM | CHAINWHEEL: FSA 44T STEEL | CASSETTE/COG: SHIMANO TIAGRA CS-HG500-10 11-34T | CHAIN: SHIMANO DEORE CN-HG54 10S | CHAIN GUARD: HESLING SUPORTIVE V2 | RIM: RODI BLACKROCK 28" BLACK | FRONT HUB: FORMULA DC-20LW QR 32H | REAR HUB: FORMULA DC-22LW QR 32H | SPOKE: SAPIM BLACK | RACK: MASSLOAD CL-905A | MUDGUARD: SKS 53MM, BLACK STAYS | LOCK: ABUS BATTERY LOCK | PEDAL: XERAMA SP-810 ALLOY W/ CATEYE | KICKSTAND: STANDWELL SW-RA031J 40MM

Pictures shown here are for illustration purpose only. Actual product may vary due to specification enhancement.

ALBOIN ALIVIO 9



△ FRAME	GEPIDA HYDROFORMING - 6061 ALLOY	⊗ REAR SHOCK	-
△ FRAME SIZE	M: 52, 56CM	⚙ REAR DERAILLEUR	SHIMANO ALIVIO SHADOW RD-M4000 9S
⌒ FORK	ZOOM 187D 700C TRAVEL: 65MM	🔧 BRAKE	TEKTRO HDT275
○ WHEEL SIZE	28"	🌀 TYRE	WTB/FREEDOM WEDGE 700X47C W/ REFLECTIVE TAPE
⚙ GEARS	9	📖 SADDLE	SELLE ROYAL ALPINE 8468 ACTEX COVER
⚡ SYSTEM	BOSCH	💡 LIGHT	AXA BLUELINE 30 / TRELOCK LS611 6-12V
ARTICLE NUMBER	30202240		
COLOR			

HEADSET: FSA NO.11N | STEM: GEPIDA TDS-299N EXT: 105MM | HANDLEBAR: PROMAX HB-3188 RIZER 640MM BB: 31,8MM | GRIP: VELO VLG-690AD2 | BRAKE LEVER: TEKTRO HDT275 | BRAKE DISC F/R: TEKTRO 160MM | SHIFTING LEVER: SHIMANO ALTUS SL-M2010 9S | SEATPOST: ZOOM SP-C207 30,9X350 MM | CRANKARM: FSA CK-200 170MM | CHAINWHEEL: FSA 38T STEEL DIRECT MOUNT | CASSETTE/COG: SHIMANO ACERA CS-HG200 11-34T 9S | CHAIN: SHIMANO CN-HG53 9S | CHAIN GUARD: HESLING SUPPORTIVE V2 44-46T | RIM: BERETTA DISC25 28" A/V, W/ EYELETS 32H | FRONT HUB: FORMULA DC-20-F FOR DISC BRAKE 32H | REAR HUB: FORMULA DC-22-R FOR DISC BRAKE 32H | SPOKE: SAPIM STAINLESS BLACK | RACK: MASSLOAD CL550 | MUDGUARD: SKS 53MM, BLACK STAYS | LOCK: ABUS BATTERY LOCK | PEDAL: XERAMA SP-940 W/ CATEYE | KICKSTAND: STANDWELL SW-RA031J ADJUSTABLE

Pictures shown here are for illustration purpose only. Actual product may vary due to specification enhancement.

ALBOIN LS ALIVIO 9

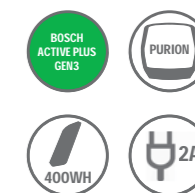

△ FRAME	GEPIDA HYDROFORMING - 6061 ALLOY	⊗ REAR SHOCK	-
△ FRAME SIZE	L: 44, 48, 52CM	⚙ REAR DERAILLEUR	SHIMANO ALIVIO SHADOW RD-M4000 9S
⌒ FORK	ZOOM 187D 700C TRAVEL: 65MM	🔧 BRAKE	TEKTRO HDT275
○ WHEEL SIZE	28"	🌀 TYRE	WTB/FREEDOM WEDGE 700X47C W/ REFLECTIVE TAPE
⚙ GEARS	9	📖 SADDLE	SELLE ROYAL ALPINE 8468 ACTEX COVER
⚡ SYSTEM	BOSCH	💡 LIGHT	AXA BLUELINE 30 / TRELOCK LS611 6-12V
ARTICLE NUMBER	30202246		
COLOR			

HEADSET: FSA NO.11N | STEM: GEPIDA TDS-299N EXT: 105MM | HANDLEBAR: PROMAX HB-3188 RIZER 640MM BB: 31,8MM | GRIP: VELO VLG-690AD2 | BRAKE LEVER: TEKTRO HDT275 | BRAKE DISC F/R: TEKTRO 160MM | SHIFTING LEVER: SHIMANO ALTUS SL-M2010 9S | SEATPOST: ZOOM SP-C207 30,9X350 MM | CRANKARM: FSA CK-200 170MM | CHAINWHEEL: FSA 38T STEEL DIRECT MOUNT | CASSETTE/COG: SHIMANO ACERA CS-HG200 11-34T 9S | CHAIN: SHIMANO CN-HG53 9S | CHAIN GUARD: HESLING SUPPORTIVE V2 44-46T | RIM: BERETTA DISC25 28" A/V, W/ EYELETS 32H | FRONT HUB: FORMULA DC-20-F FOR DISC BRAKE 32H | REAR HUB: FORMULA DC-22-R FOR DISC BRAKE 32H | SPOKE: SAPIM STAINLESS BLACK | RACK: MASSLOAD CL550 | MUDGUARD: SKS 53MM, BLACK STAYS | LOCK: ABUS BATTERY LOCK | PEDAL: XERAMA SP-940 W/ CATEYE | KICKSTAND: STANDWELL SW-RA031J ADJUSTABLE

Pictures shown here are for illustration purpose only. Actual product may vary due to specification enhancement.

TISIA ALIVIO 9 BAF-M



△ FRAME	GEPIDA HYDROFORMING - 6061 ALLOY	⊗ REAR SHOCK	-
△ FRAME SIZE	M:52, 56CM	⚙ REAR DERAILLEUR	SHIMANO ALIVIO RD-M4000 9S
⌒ FORK	ZOOM 187D 700C TRAVEL: 65MM	🔑 BRAKE	TEKTRO HD-T275
○ WHEEL SIZE	28"	🌀 TYRE	WTB/FREEDOM WEDGE 700X47C W/ REFLECTIVE TAPE
⚙ GEARS	9	📉 SADDLE	SELLE ROYAL ALPINE HC
⚡ SYSTEM	BAFANG	💡 LIGHT	BÜCHEL UNILED 15 / TRELOCK LS611 6-12V
ARTICLE NUMBER		COLOR	
30200970		30200970A	

HEADSET: FSA NO.11N | STEM: GEPIDA TDS-299N ADJUSTABLE EXT: 105MM | HANDLEBAR: GEPIDA ALLOY 640 MM | GRIP: VELO VLG-690AD2 | BRAKE LEVER: TEKTRO HD-T275 | BRAKE DISC F/R: TEKTRO 160MM | SHIFTING LEVER: SHIMANO ALTUS SL-M2010 9S | SEATPOST: GEPIDA ALLOY, SP-C207 27,2X300 MM | CRANKARM: PROWHEEL 170MM | CHAINWHEEL: BAFANG 38T STEEL | CASSETTE/COG: SHIMANO CS-HG200 11-34T 9S | CHAIN: SHIMANO CN-HG53 | RIM: BERETTA DISC25 28" 32H | FRONT HUB: FORMULA DC-20 QR 32H | REAR HUB: FORMULA DC-22 QR 32H | SPOKE: SAPIM STAINLESS BLACK | MUDGUARD: ORION | CHAIN GUARD: HERRMANS HALO 38T | LOCK: AXA BATTERY LOCK | PEDAL: XERAMA SP-807 | RACK: MASSLOAD CL-550 | KICKSTAND: HEBIE 668MI 18MM

Pictures shown here are for illustration purpose only. Actual product may vary due to specification enhancement.

TISIA LS ALIVIO 9 BAF-M



△ FRAME	GEPIDA HYDROFORMING - 6061 ALLOY	⊗ REAR SHOCK	-
△ FRAME SIZE	L:44, 48, 52CM	⚙ REAR DERAILLEUR	SHIMANO ALIVIO RD-M4000 9S
⌒ FORK	ZOOM 187D 700C TRAVEL: 65MM	🔑 BRAKE	TEKTRO HD-T275
○ WHEEL SIZE	28"	🌀 TYRE	WTB/FREEDOM WEDGE 700X47C W/ REFLECTIVE TAPE
⚙ GEARS	9	📉 SADDLE	SELLE ROYAL ALPINE HC
⚡ SYSTEM	BAFANG	💡 LIGHT	BÜCHEL UNILED 15 / TRELOCK LS611 6-12V
ARTICLE NUMBER		COLOR	
30200976		30200976A	

HEADSET: FSA NO.11N | STEM: GEPIDA TDS-299N ADJUSTABLE EXT: 105MM | HANDLEBAR: GEPIDA ALLOY 640 MM | GRIP: VELO VLG-690AD2 | BRAKE LEVER: TEKTRO HD-T275 | BRAKE DISC F/R: TEKTRO 160MM | SHIFTING LEVER: SHIMANO ALTUS SL-M2010 9S | SEATPOST: GEPIDA ALLOY, SP-C207 27,2X300 MM | CRANKARM: PROWHEEL 170MM | CHAINWHEEL: BAFANG 38T STEEL | CASSETTE/COG: SHIMANO CS-HG200 11-34T 9S | CHAIN: SHIMANO CN-HG53 | RIM: BERETTA DISC25 28" 32H | FRONT HUB: FORMULA DC-20 QR 32H | REAR HUB: FORMULA DC-22 QR 32H | SPOKE: SAPIM STAINLESS BLACK | MUDGUARD: ORION | CHAIN GUARD: HERRMANS HALO 38T | LOCK: AXA BATTERY LOCK | PEDAL: XERAMA SP 807 | RACK: MASSLOAD CL-550 | KICKSTAND: HEBIE 668MI 18MM

Pictures shown here are for illustration purpose only. Actual product may vary due to specification enhancement.

THORIS VOYAGE XT 10



△ FRAME	GEPIDA 6061 ALLOY	⊗ REAR SHOCK	-
△ FRAME SIZE	53/44 CM	⚙ REAR DERAILLEUR	SHIMANO XT SHADOW RD-T8000 10S
⌒ FORK	SUNTOUR NCX-D AIR LO 700C TRAVEL: 63MM	🔧 BRAKE	SHIMANO DEORE BR-MT500 + ALIVIO BR-T4000
○ WHEEL SIZE	28"	🌀 TYRE	SCHWALBE ENERGIZER+ 47-622 W/ REFELCTIVE TAPE
⚙ GEARS	10	📉 SADDLE	SELLE ROYAL ARIEL ACTEX
⚡ SYSTEM	BOSCH	💡 LIGHT	TRELOCK AIRFLOW 70 / TRELOCK LS611 6-12V
ARTICLE NUMBER	30202600		
	COLOR	30202600A	

HEADSET: FSA NO.11N | STEM: GEPIDA TDS-D299 ADJUSTABLE | STEM REAR: GEPIDA TDS-D299 ADJUSTABLE | HANDLEBAR: PROMAX HB-3188 720MM RISE: 30MM | HANDLE BAR REAR: GEPIDA ALLOY 720 MM / 640 MM OS | GRIP/GRIP REAR: VELO VLG-1185D3 ERGO W/ CLAMP | BRAKE LEVER: SHIMANO DEORE BL-MT500 + SHIMANO BL-T4010 | BRAKE DISC F/R: SHIMANO DEORE RT-54M 180MM | SHIFTING LEVER: SHIMANO DEORE SL-T6000 10S | SEAT POST: KALLOY SPDC1/GEPIDA 27,2X300MM | CRANKARM: FSA CK-745 170MM | CHAINWHEEL: FSA 38T STEEL W/ CHAINGUARD / ALIVIO 38T/48T | CASSETTE/COG: SHIMANO TIAGRA CS-HG500-10 11-34T | CHAIN: SHIMANO CN-HG54 10S | CHAIN GUARD: HESLING SUPORTIVE V2 | RIM: RODI AIRLINE1 28", 32H | FRONT HUB: SHIMANO ALIVIO HB-M4050 | REAR HUB: SHIMANO ALIVIO FH-MT400 X12 + AXLE | SPOKE: SAPIM 13G STAINLESS | RACK: RACKTIME TUBUS 28" ALLOY | MUDGUARD: SKS MATT BLACK 55MM | LOCK: ABUS BATTERY LOCK | PEDAL: XERAMA SP-811 W/ CATEYE | KICKSTAND: URSUS KING 28"

Pictures shown here are for illustration purpose only. Actual product may vary due to specification enhancement.

THORIS XT 10



△ FRAME	GEPIDA 6061 ALLOY	⊗ REAR SHOCK	-
△ FRAME SIZE	53/44 CM	⚙ REAR DERAILLEUR	SHIMANO XT SHADOW RD-T8000 10S
⌒ FORK	SUNTOUR NCX-D AIR LO 700C TRAVEL: 63MM	🔧 BRAKE	SHIMANO DEORE BR-MT500 + ALIVIO BR-T4000
○ WHEEL SIZE	28"	🌀 TYRE	SCHWALBE ENERGIZER+ 47-622 W/ REFELCTIVE TAPE
⚙ GEARS	10	📉 SADDLE	SELLE ROYAL ARIEL ACTEX
⚡ SYSTEM	BOSCH	💡 LIGHT	TRELOCK AIRFLOW 70 / TRELOCK LS611 6-12V
ARTICLE NUMBER	30202560		
	COLOR	30202560A	

HEADSET: FSA NO.11N | STEM: GEPIDA TDS-D299 ADJUSTABLE | HANDLEBAR: GEPIDA ALLOY 720 MM / 640 MM OS | GRIP: VELO VLG-1185D3 | BRAKE LEVER: SHIMANO DEORE BL-MT500 + GEPIDA ALLOY XL92 | BRAKE DISC F/R: SHIMANO DEORE RT-54M 180MM | SHIFTING LEVER: SHIMANO DEORE SL-T6000 10S | SEATPOST: KALLOY SPDC1/GEPIDA 27,2X300MM | CRANKARM: FSA CK-745 170 MM GEN4/SHIMANO ALIVIO FC-T4010 | CHAINWHEEL: FSA 38T STEEL W/ CHAINGUARD / ALIVIO 38T/48T | CASSETTE/COG: SHIMANO TIAGRA CS-HG500-10 11-34T 10S | CHAIN: SHIMANO DEORE CN-HG54 10S | RIM: RODI AIRLINE1 28", 32H | FRONT HUB: SHIMANO ALIVIO HB-M4050 QR 32H | REAR HUB: SHIMANO ALIVIO FH-MT400 X12 32H | SPOKE: SAPIM 13G STAINLESS STEEL | RACK: MASSLOAD CL 905A | MUDGUARD: SKS 53MM, BLACK STAYS | CHAIN GUARD: - | LOCK: - | PEDAL: XERAMA SP-811 ALLOY W/ CATEYE | KICKSTAND: URSUS KING 28"

Pictures shown here are for illustration purpose only. Actual product may vary due to specification enhancement.



MTB & ATB

STRONG, FAST, HARD

The torquey Bosch engines combined with the performance of the cyclist provide an experience unprecedented in mountain biking: you can pedal up rough terrains in a sporty yet convenient manner and reach heights you haven't been before, or have but with great effort.

MTB & ATB E-BIKE

ASGARD PRO XT 11



△ FRAME	GEPIDA GRAVITY CASTING - 6061 ALLOY	⊗ REAR SHOCK	-
△ FRAME SIZE	15" 17" 19" 21"	⚙ REAR DERAILLEUR	SHIMANO XT SHADOW+ RD-M8000 11S
⌒ FORK	ROCKSHOX RECON RL CROWN TAPERED 15QR TRAVEL: 100MM	🛞 BRAKE	SHIMANO DEORE BR-M6000
○ WHEEL SIZE	29"	🌀 TYRE	SCHWALBE RACING RALPH 29X2,25 SNAKESKIN
⚙ GEARS	11	📵 SADDLE	SELLE ROYAL SETA S1
⚡ SYSTEM	BOSCH	💡 LIGHT	-

ARTICLE NUMBER

30202080

29"

COLOR

30202080A

30202080B

HEADSET: FSA NO.42B | STEM: TRANZX JDST-58A EXT: 70/80/90MM | HANDLEBAR: PROMAX HB-3019DBFT FLAT TOP 720MM BB: 31,8MM | GRIP: VELO VLG-775-12D2 + VLP-171
 BRAKE LEVER: SHIMANO DEORE BL-M6000 | BRAKE DISC F/R: SHIMANO DEORE RT-54M 180MM / RT-54S 160MM | SHIFTING LEVER: SHIMANO SLX SL-M7000-11 I-SPECII 11S
 SEATPOST: GEPIDA SP-226 30,9X400MM | CRANKARM: FSA CK-745 170/175MM | CHAINWHEEL: FSA 15T STEEL | CASSETTE/COG: SHIMANO SLX CS-M7000 11-40T 11S | CHAIN:
 SHIMANO CN-HG601-11 11S | RIM: RODI BLACKROCK 29" 622X21C 32H | FRONT HUB: SHIMANO DEORE HB-M6010 QR15 32H | REAR HUB: SHIMANO DEORE FH-M6000 QR 32H |
 SPOKE: SAPIM STAINLESS STEEL BLACK | RACK: - | MUDGUARD: - | CHAIN COVER: - | LOCK: ABUS BATTERY LOCK | PEDAL: XERAMA SP-610 ALLOY W/ CATEYE

ASGARD SLX 10

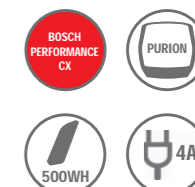

△ FRAME	GEPIDA GRAVITY CASTING - 6061 ALLOY	⊗ REAR SHOCK	-
△ FRAME SIZE	15" 17" 19" 21"	⚙ REAR DERAILLEUR	SHIMANO XT SHADOW+ RD-M786 10S
⌒ FORK	ROCKSHOX RECON RL CROWN TAPERED 15QR BOOST TRAVEL: 100MM	🛞 BRAKE	SHIMANO DEORE BR-M6000
○ WHEEL SIZE	29"	🌀 TYRE	SCHWALBE RACING RALPH/RAY 29X2,25 SNAKESKIN
⚙ GEARS	10	📵 SADDLE	SELLE ROYAL SETA S1
⚡ SYSTEM	BOSCH	💡 LIGHT	-

ARTICLE NUMBER

30202070

29"

COLOR

30202070A

30202070B

HEADSET: FSA NO.42B | STEM: TRANZX JDST-58A EXT: 60/70/80/90MM | HANDLEBAR: PROMAX HB-3019DBFT FLAT TOP 720MM BB: 31,8MM | GRIP: VELO VLG-775-12D2 + VLP-171
 BRAKE LEVER: SHIMANO DEORE BL-M6000 | BRAKE DISC F/R: SHIMANO DEORE RT-54M 180MM / RT-54S 160MM | SHIFTING LEVER: SHIMANO DEORE SL-M6000 I-SPECII 10S |
 SEATPOST: GEPIDA SP-226 30,9X400MM | CRANKARM: FSA CK-745 170/175MM | CHAINWHEEL: FSA 15T STEEL | CASSETTE/COG: SHIMANO TIAGRA CS-HG500-10 11-34T 10S | CHAIN:
 SHIMANO DEORE CN-HG54 10S | RIM: RODI TRY25 29" 622X25C 32H TUBELESS | FRONT HUB: SHIMANO DEORE HB-M6010B 110X15 32H | REAR HUB: SHIMANO DEORE FH-
 M6010B 148X12 32H | SPOKE: SAPIM STAINLESS STEEL BLACK | RACK: - | MUDGUARD: - | CHAIN GUARD: - | LOCK: ABUS BATTERY LOCK | PEDAL: XERAMA SP-610 ALLOY W/ CATEYE

Pictures shown here are for illustration purpose only. Actual product may vary due to specification enhancement.

RUGA PRO DEORE 10



△ FRAME	CEPIDA HYDROFORMING - 6061 ALLOY
△ FRAME SIZE	17" 19" 21"
⌒ FORK	SUNTOUR XCR 32 RL-R COIL TAPERED QR15 BOOST TRAVEL: 100MM
○ WHEEL SIZE	29"
⚙️ GEARS	10
⚡ SYSTEM	BOSCH

⊗ REAR SHOCK	-
⚙️ REAR DERAILLEUR	SHIMANO DEORE SHADOW+ RD-M6000GS 10S
⚙️ BRAKE	SHIMANO ACERA BR-MT400
🌀 TYRE	SCHWALBE RAPID ROB 29X2,35
📏 SADDLE	SELLE ROYAL SETA S1
💡 LIGHT	-

ARTICLE NUMBER
30202030

29"

COLOR



30202030A



30202030B

HEADSET: FSA NO.42B | STEM: TRANZX JDST-58A EXT: 70/80/90MM | HANDLEBAR: PROMAX HB-3188 RIZER 720MM BB: 31,8MM | GRIP: VELO VLG-775-12D2 + VLP-171 | BRAKE LEVER: SHIMANO ACERA BL-MT401 | BRAKE DISC F/R: SHIMANO DEORE RT-56M 180MM / RT-56S 160MM | SHIFTING LEVER: SHIMANO DEORE SL-M6000 10S | SEATPOST: KALLOY SPDC1 30,9X400MM | CRANKARM: FSA CK-220 170/175MM | CHAINWHEEL: FSA 34T MEGATOOTH STEEL | CASSETTE/COG: SHIMANO DEORE CS-HG500-10 11-42T 10S | CHAIN: SHIMANO DEORE CN-HG54 10S | RIM: RODI TRYP25 29" 622X25C 32H TUBELESS | FRONT HUB: SHIMANO ALIVIO HB-MT400B 32H 110X15 | REAR HUB: SHIMANO ALIVIO FH-MT400B 32H 148X12 | SPOKE: SAPIM STAINLESS STEEL BLACK | RACK: - | MUDGUARD: - | CHAIN GUARD: - | LOCK: ABUS BATTERY LOCK | PEDAL: XERAMA SP-610 ALLOY W/ CATEYE

Pictures shown here are for illustration purpose only. Actual product may vary due to specification enhancement.

RUGA PRO DEORE 10



△ FRAME	CEPIDA HYDROFORMING - 6061 ALLOY
△ FRAME SIZE	17" 19" 21"
⌒ FORK	SUNTOUR XCR 32 RL-R COIL TAPERED QR15 BOOST TRAVEL: 100MM
○ WHEEL SIZE	27,5"
⚙️ GEARS	10
⚡ SYSTEM	BOSCH

⊗ REAR SHOCK	-
⚙️ REAR DERAILLEUR	SHIMANO DEORE SHADOW+ RD-M6000GS 10S
⚙️ BRAKE	SHIMANO ACERA BR-MT400
🌀 TYRE	SCHWALBE SMART SAM 27,5X2,6
📏 SADDLE	SELLE ROYAL SETA S1
💡 LIGHT	-

ARTICLE NUMBER
30202050

27,5"

COLOR



30202050A



30202050B

HEADSET: FSA NO.42B | STEM: TRANZX JDST-58A EXT: 70/80/90MM | HANDLEBAR: PROMAX HB-3188 RIZER 720MM BB: 31,8MM | GRIP: VELO VLG-775-12D2 + VLP-171 | BRAKE LEVER: SHIMANO ACERA BL-MT401 | BRAKE DISC F/R: SHIMANO DEORE RT-56M 180MM / RT-56S 160MM | SHIFTING LEVER: SHIMANO DEORE SL-M6000 10S | SEATPOST: KALLOY SPDC1 30,9X400MM | CRANKARM: FSA CK-220 170/175MM | CHAINWHEEL: FSA 34T MEGATOOTH STEEL | CASSETTE/COG: SHIMANO DEORE CS-HG500-10 11-42T 10S | CHAIN: SHIMANO DEORE CN-HG54 10S | RIM: RODI TRYP30 27,5" 584X30C 32H TUBELESS | FRONT HUB: SHIMANO ALIVIO HB-MT400B 32H 110X15 | REAR HUB: SHIMANO ALIVIO FH-MT400B 32H 148X12 | SPOKE: SAPIM STAINLESS STEEL BLACK | RACK: - | MUDGUARD: - | CHAIN GUARD: - | LOCK: ABUS BATTERY LOCK | PEDAL: XERAMA SP-610 ALLOY W/ CATEYE

Pictures shown here are for illustration purpose only. Actual product may vary due to specification enhancement.

SIRMIUM PRO DEORE 10



△ FRAME	GEPIDA HYDROFORMING - 6061 ALLOY	⊗ REAR SHOCK	-
△ FRAME SIZE	15" 17" 19" 21"	⚙️ REAR DERAILLEUR	SHIMANO DEORE SHADOW+ RD-M6000GS 10S
⌒ FORK	SUNTOUR XCR 32 RL-R COIL TAPERED QR TRAVEL: 100MM	🔒 BRAKE	TEKTRO HD-M275
○ WHEEL SIZE	29"	🌀 TYRE	SCHWALBE RAPID ROB 29X2,25
⚙️ GEARS	10	📉 SADDLE	SELLE ROYAL SETA S1
⚡ SYSTEM	BOSCH	💡 LIGHT	-
ARTICLE NUMBER	30202040	COLOR	
	29"		30202040A 30202040B

HEADSET: FSA NO.42B | STEM: TRANZX JDST-58A EXT: 60/70/80/90MM | HANDLEBAR: PROMAX HB-3019DBFT FLAT TOP 720MM BB: 31,8MM | GRIP: VELO VLG-775-12D2 + VLP-171 | BRAKE LEVER: TEKTRO HD-M275 | BRAKE DISC F/R: TEKTRO 180/160MM | SHIFTING LEVER: SHIMANO DEORE SL-M6000 10S | SEATPOST: KALLOY SPDC1 30,9X400MM | CRANKARM: FSA CK-220 170/175MM | CHAINWHEEL: FSA 34T MEGATOOTH STEEL | CASSETTE/COG: SHIMANO DEORE CS-HG500-10 11-42T 10S | CHAIN: SHIMANO DEORE CN-HG54 10S | RIM: RODI BLACKROCK 29" 622X23C 32H | FRONT HUB: FORMULA DC-20LW QR 32H | REAR HUB: FORMULA DC-22W QR 32H | SPOKE: SAPIM STAINLESS STEEL BLACK | MUDGUARD: - | CHAIN GUARD: - | LOCK: ABUS BATTERY LOCK | PEDAL: XERAMA SP-610 ALLOY W/ CATEYE

Pictures shown here are for illustration purpose only. Actual product may vary due to specification enhancement.

SIRMIUM DEORE 9

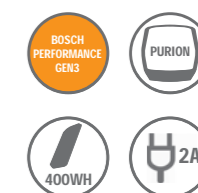

△ FRAME	GEPIDA - 6061 ALLOY	⊗ REAR SHOCK	-
△ FRAME SIZE	15" 17" 19" 21"	⚙️ REAR DERAILLEUR	SHIMANO DEORE SHADOW RD-M592 9S
⌒ FORK	SUNTOUR XCR 32 LO COIL QR TRAVEL: 120MM	🔒 BRAKE	TEKTRO HD-M275
○ WHEEL SIZE	29"	🌀 TYRE	SCHWALBE SMART SAM 27,5X2,6
⚙️ GEARS	9	📉 SADDLE	SELLE ROYAL SETA S1
⚡ SYSTEM	BOSCH	💡 LIGHT	-
ARTICLE NUMBER	30202000	COLOR	
	29"		30202000A

HEADSET: FSA NO.42B-1 | STEM: TRANZX JDST-58A EXT: 60/70/80/90MM | HANDLEBAR: PROMAX HB-3188 RIZER 720MM BB: 31,8MM | GRIP: VELO VLG-775-12D2 + VLP-171 | BRAKE LEVER: TEKTRO HD-M275 | BRAKE DISC F/R: TEKTRO 180/160MM | SHIFTING LEVER: SHIMANO ALTUS SL-M2010 9S | SEATPOST: KALLOY SPDC1 30,9X400MM | CRANKARM: FSA CK-200 170MM | CHAINWHEEL: FSA 38T STEEL DIRECT MOUNT W/ CHAINGUARD | CASSETTE/COG: SHIMANO ACERA CS-HG200 11-34T 9S | CHAIN: SHIMANO CN-HG53 9S | RIM: RODI BLACKROCK 29" 622X23C 32H | FRONT HUB: FORMULA DC-20LW QR 32H | REAR HUB: FORMULA DC-22W QR 32H | SPOKE: SAPIM STAINLESS STEEL BLACK | RACK: - | MUDGUARD: - | CHAIN GUARD: - | LOCK: ABUS BATTERY LOCK | PEDAL: XERAMA SP-610 ALLOY W/ CATEYE

Pictures shown here are for illustration purpose only. Actual product may vary due to specification enhancement.

SIRMIUM DEORE 9



△ FRAME	GEPIDA - 6061 ALLOY	⊖ REAR SHOCK	-
△ FRAME SIZE	15" 17" 19" 21"	⚙️ REAR DERAILLEUR	SHIMANO DEORE SHADOW RD-M592 9S
⌒ FORK	SUNTOUR XCR 32 LO COIL QR TRAVEL: 120MM	🔧 BRAKE	TEKTRO HD-M275
○ WHEEL SIZE	27,5"	🛞 TYRE	SCHWALBE SMART SAM 27,5X2,6
⚙️ GEARS	9	📉 SADDLE	SELLE ROYAL SETA S1
⚡ SYSTEM	BOSCH	💡 LIGHT	-

ARTICLE NUMBER
30202010

27,5"

COLOR
 30202010A

HEADSET: FSA NO.42B-1 | STEM: TRANZX JDST-58A EXT: 60/70/80/90MM | HANDLEBAR: PROMAX HB-3188 RIZER 720MM BB: 31,8MM | GRIP: VELO VLG-775-12D2 + VLP-171 | BRAKE LEVER: TEKTRO HD-M275 | BRAKE DISC F/R: TEKTRO 180/160MM | SHIFTING LEVER: SHIMANO ALTUS SL-M2010 9S | SEATPOST: KALLOY SPDC1 30,9X400MM | CRANKARM: FSA CK-200 170MM | CHAINWHEEL: FSA 38T STEEL DIRECT MOUNT W/ CHAINGUARD | CASSETTE/COG: SHIMANO ACERA CS-HG200 11-34T 9S | CHAIN: SHIMANO CN-HG53 9S | RIM: RODI BLACKROCK 27,5" 584X23C 32H | FRONT HUB: FORMULA DC-20LW QR 32H | REAR HUB: FORMULA DC-22W QR 32H | SPOKE: SAPIM STAINLESS STEEL BLACK | RACK: - | MUDGUARD: - | CHAIN GUARD: - | LOCK: ABUS BATTERY LOCK | PEDAL: XERAMA SP-610 ALLOY W/ CATEYE

Pictures shown here are for illustration purpose only. Actual product may vary due to specification enhancement.

BERIG DEORE 10

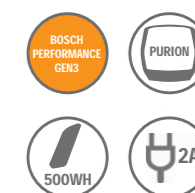

△ FRAME	GEPIDA HYDROFORMING - 6061 ALLOY	⊖ REAR SHOCK	-
△ FRAME SIZE	17" 19"	⚙️ REAR DERAILLEUR	SHIMANO DEORE SHADOW+ RD-M6000 10S
⌒ FORK	SUNTOUR XCM-ATB HLO QR TRAVEL: 100MM	🔧 BRAKE	TEKTRO HD-M275
○ WHEEL SIZE	29"	🛞 TYRE	SCHWALBE SMART SAM 29X2,1
⚙️ GEARS	10	📉 SADDLE	SELLE ROYAL SETA S1
⚡ SYSTEM	BOSCH	💡 LIGHT	AXA BLUELINE 30 / TRELOCK LS631 6-12V

ARTICLE NUMBER
30202580

29"

COLOR
 30202580A 30202580B

HEADSET: FSA NO.42B-1 | STEM: TRANZX JDST-58A EXT: 60/70/80/90MM | HANDLEBAR: PROMAX HB-3188 RIZER 720MM BB: 31,8MM | GRIP: VELO VLG-775-12D2 + VLP-171 | BRAKE LEVER: TEKTRO HD-M275 | BRAKE DISC F/R: TEKTRO 180/160MM | SHIFTING LEVER: SHIMANO DEORE SL-M6000 10S | SEATPOST: KALLOY SPDC1 30,9X400MM | CRANKARM: FSA CK-200 170MM | CHAINWHEEL: FSA 38T DIRECT MOUNT STEEL W/ CHAINGUARD | CASSETTE/COG: SHIMANO TIAGRA CS-HG500-10 11-34T 10S | CHAIN: SHIMANO DEORE CN-HG54 10S | RIM: RODI BLACKROCK 29" 622X21C 32H | FRONT HUB: FORMULA DC-20LW QR 32H | REAR HUB: FORMULA DC-22W QR 32H | SPOKE: SAPIM STAINLESS STEEL BLACK | MUDGUARD: SKS 65MM, BLACK STAYS | CHAIN GUARD: INTEGRATED CHAINGUARD | LOCK: ABUS BATTERY LOCK | PEDAL: VP 536 X20T W/CATEYE | RACK: STANDWELL SW-CA535S ALLOY | KICKSTAND: HEBIE 668M1 18MM

Pictures shown here are for illustration purpose only. Actual product may vary due to specification enhancement.

BERIG DEORE 10



△ FRAME	GEPIDA HYDROFORMING - 6061 ALLOY	⊗ REAR SHOCK	-
△ FRAME SIZE	15" 17"	⚙️ REAR DERAILLEUR	SHIMANO DEORE SHADOW+ RD-M6000 10S
⌒ FORK	SUNTOUR XCM-ATB HLO QR TRAVEL: 100MM	🔧 BRAKE	TEKTRO HD-M275
○ WHEEL SIZE	27,5"	🌀 TYRE	SCHWALBE SMART SAM 29X2,1
⚙️ GEARS	10	📵 SADDLE	SELLE ROYAL SETA S1
⚡ SYSTEM	BOSCH	💡 LIGHT	AXA BLUELINE 30 / TRELOCK LS631 6-12V

ARTICLE NUMBER
30202570

27,5"

COLOR		COLOR	
	30202570A		30202570B

HEADSET: FSA NO.42B-1 | STEM: TRANZX JDST-58A EXT: 60/70/80/90MM | HANDLEBAR: PROMAX HB-3188 RIZER 720MM BB: 31,8MM | GRIP: VELO VLG-775-12D2 + VLP-171 | BRAKE LEVER: TEKTRO HD-M275 | BRAKE DISC F/R: TEKTRO 180/160MM | SHIFTING LEVER: SHIMANO DEORE SL-M6000 10S | SEATPOST: KALLOY SPDC1 30,9X400MM | CRANKARM: FSA CK-200 170MM | CHAINWHEEL: FSA 38T DIRECT MOUNT STEEL W/ CHAINGUARD | CASSETTE/COG: SHIMANO TIAGRA CS-HG500-10 11-34T 10S | CHAIN: SHIMANO DEORE CN-HC54 10S | RIM: RODI BLACKROCK 27,5" 584X21C 32H | FRONT HUB: FORMULA DC-20LW QR 32H | REAR HUB: FORMULA DC-22W QR 32H | SPOKE: SAPIM STAINLESS STEEL BLACK | MUDGUARD: SKS 65MM, BLACK STAYS | CHAIN GUARD: INTEGRATED CHAINGUARD | LOCK: ABUS BATTERY LOCK | PEDAL: VP 536 X20T W/CATEYE | RACK: STANDWELL SW-CA535S ALLOY | KICKSTAND: HEBIE 668M1 18MM

Pictures shown here are for illustration purpose only. Actual product may vary due to specification enhancement.

BERIG LS DEORE 10



△ FRAME	GEPIDA SPECIAL HYDROFORMING - 6061 ALLOY	⊗ REAR SHOCK	-
△ FRAME SIZE	15" 17" 19"	⚙️ REAR DERAILLEUR	SHIMANO DEORE SHADOW+ RD-M6000 10S
⌒ FORK	SUNTOUR XCM ATB HLO DS 27,5" 1 1/8" TRAVEL: 100MM	🔧 BRAKE	TEKTRO HD-M275
○ WHEEL SIZE	27,5"	🌀 TYRE	SCHWALBE SMART SAM 27,5X2,25
⚙️ GEARS	10	📵 SADDLE	SELLE ROYAL SETA S1
⚡ SYSTEM	BOSCH	💡 LIGHT	AXA BLUELINE 30 / TRELOCK LS631 6-12V

ARTICLE NUMBER
30202575

27,5"

COLOR		COLOR	
	30202575A		30202575B

HEAD SET: FSA NO.11Q SEMI INTEGRATED | STEM: TRANZX JD-ST58A A-HEAD BB: 31,8MM | HANDLE BAR: PROMAX HB-3188 BB: 31,8MM W: 720MM RISE:30MM | GRIP: VELO VLG-77512D2 W/ CLAMP | BRAKE LEVER: TEKTRO HD-T275 | BRAKE: TEKTRO HD-T275 | BRAKE DISC F/R: 180/160 MM | SHIFTING LEVER: SHIMANO DEORE SL-M6000 10S | SEAT POST: KALLOY SPDC1 30,9X400 SBB | CRANKARM: FSA CK-200 170MM | CHAINWHEEL: FSA 38T DIRECT MOUNT STEEL W/ CHAINGUARD | CASSETTE/COG: SHIMANO TIAGRA CS-HG500-10 11-34T | CHAIN: SHIMANO DEORE CN-HC54 10S | RIM: RODI BLACKROCK 27,5" 584X21C 32H | FRONT HUB: FORMULA DC-20LW QR 32H | REAR HUB: FORMULA DC-22W QR 32H | SPOKE: SAPIM STAINLESS STEEL BLACK | RACK: STANDWELL SW-CA535S ALLOY | MUDGUARD: SKS MATT BLACK 65MM | CHAIN GUARD: HESLING SUPORTIVE V2 38T | LOCK: ABUS BATTERY LOCK | PEDAL: VP-536 W/ CATEYE | KICKSTAND: STANDWELL SW-RA031J ADJUSTABLE

Pictures shown here are for illustration purpose only. Actual product may vary due to specification enhancement.

GILPIL ALIVIO 9



FRAME	GEPIDA HYDROFORMING - 6061 ALLOY	REAR SHOCK	-
FRAME SIZE	14"	REAR DERAILLEUR	SHIMANO ALIVIO SHADOW RD-M4000 9S
FORK	SUNTOUR XCT JR-L HLO 24" TRAVEL: 80MM	BRAKE	TEKTRO HD-M275
WHEEL SIZE	24"	TYRE	SCHWALBE SMART SAM 24X2,1
GEARS	9	SADDLE	SELLE ROYAL HELLO
SYSTEM	BOSCH	LIGHT	-

ARTICLE NUMBER

30201540

24"

COLOR

30201540A

HEADSET: FSA NO.11N | STEM: TRANZX JDST-58A EXT: 60MM | HANDLEBAR: PROMAX HB-3188 RIZER 640MM BB: 31,8MM | GRIP: VELO VLG-207 KRATON | BRAKE LEVER: TEKTRO HD-M275 | BRAKE DISC F/R: TEKTRO 160MM | SHIFTING LEVER: SHIMANO ALTUS SL-M2010 9S | SEATPOST: ZOOM SP-C207 27,2X300 MM | CRANKARM: FSA CK-200 GEN3 152MM | CHAINWHEEL: FSA 32T STEEL DIRECT MOUNT W/ CHAINGUARD | CASSETTE/COG: SHIMANO ACERA CS-HG200 11-34T 9S | CHAIN: SHIMANO CN-HG53 9S | RIM: BERETTA MT240E 24" 507X19C W/ EYELET 32H | FRONT HUB: FORMULA DC-20LW QR 32H | REAR HUB: FORMULA DC-22W QR 32H | SPOKE: SAPIM STAINLESS STEEL BLACK | RACK: - | MUDGUARD: - | CHAIN GUARD: - | LOCK: ABUS BATTERY LOCK | PEDAL: XERAMA SP-400 PP BODY W/ CATEYE

Pictures shown here are for illustration purpose only. Actual product may vary due to specification enhancement.

LIFELONG WARRANTY ON GEPIDA FRAMES

In the framework of a lifetime warranty, Gepida undertakes to repair or replace the faulty or damaged frames of bikes in a short time by our team or directly through the distributor. Both the expertise of our engineers and high technology of our professional manufacturing can assure a lifetime warranty on the frames of our bicycles. This is why long-term durability and simplicity of use is at the core of our product philosophy.

To activate the warranty process, remember to register on our website at the bike registration section. The warranty is validated automatically along with the ownership. Your satisfaction and the joy of riding without any problems for many years to come is essential to us.





TREKKING

DESIGNED FOR LONG-TERM

As the category name implies, these bikes are designed to cover longer distances. The strong frame and the highest possible quality brakes for the given model guarantee untroubled trips. Heavier bags are not a problem, and your trip can be dynamic and speedy (as well) if you like, due to the sportier saddle position (we lean a bit more than on City bikes, but not nearly as much as on Road bikes). If we are considering long distances, we should not overlook the fact that the carrier can bear up to 25 kg load, and the springy seatpost and the suspension offer support during the 10-, 100- and 1,000-kilometer pedalling.

TREKKING BICYCLES

ALBOIN 900



△ FRAME	CEPIDA HYDROFORMING - 6061 ALLOY	👤 BRAKE	SHIMANO ACERA BR-M395
△ FRAME SIZE	48, 52, 56CM	👤 FRONT DERAILLEUR	SHIMANO DEORE FD-T6000 TOP SWING DUAL PULL 31,8MM
○ WHEEL SIZE	28"	👤 REAR DERAILLEUR	SHIMANO XT RDT8000 SGS SHADOW
⌒ FORK	SUNTOUR NCX-D 700C LO 63MM	👤 TYRE	SCHWALBE MARATHON+ SMARTGUARD 40-622 W/ REFLECTIVE TAPE
⚙️ GEARS	30	👤 SADDLE	SELLE ROYAL ARIEL HRC GEL
📦 WEIGHT	18,6 KG	👤 LIGHT	AXA PICO30 W/ STANDLIGHT / SLIM W/ STANDLIGHT

ARTICLE NUMBER
30200390

COLOR
 **30200390A**



HEAD SET: FSA TH807ST THREADED 11/8" | STEM: CEPIDA MQ-565 EXT: 85/105MM BB: 25,4MM | HANDLE BAR: CEPIDA ALLOY AL-155TP W: 640MM BB: 25,4MM | GRIP: VELO VLG-649 AD2 | BRAKE LEVER: SHIMANO ACERA BL-M425 | BRAKE DISC F/R: SHIMANO RT-56S 160MM | SHIFTING LEVER: SHIMANO LX SL-T670 3X10S | SEAT POST: KALLOY SP-509 27,2X300MM | CRANKSET: SHIMANO LX FC-T551 48-36-26T 170/175MM | BOTTOM BRACKET: SHIMANO SM-BB INTEGRATED | CASSETTE/COG: SHIMANO TIAGRA CS-HG500-10 11-34T 10S | CHAIN: SHIMANO DEORE CN-HG54 10S | RIM: RODI EXCALIBUR XC 28", 32H | FRONT HUB: SHIMANO DH-3D32 QR 32H | REAR HUB: FORMULA DC-22 QR 32H | SPOKE: SAPIM STAINLESS BLACK | RACK: MASSLOAD CL-550 | MUDGUARD: SKS | CHAIN COVER: - | PEDAL: XERAMA SP-811 ALLOY W/ CATEYE

ALBOIN 700



△ FRAME	GEPIDA HYDROFORMING - 6061 ALLOY	🛞 BRAKE	SHIMANO ACERA BR-M396
△ FRAME SIZE	48, 52, 56CM	👉 FRONT DERAILLEUR	SHIMANO DEORE FD-T6000 TOP SWING DUAL PULL 31,8MM
○ WHEEL SIZE	28"	👉 REAR DERAILLEUR	SHIMANO RD-T6000, DEORE, SGS 10SPEED, SHADOW DESIGN
⌒ FORK	SUNTOUR NCX-D 700C LO 63MM	🌀 TYRE	SCHWALBE SILENTO KEVLARGUARD 42-622 W/ REFELCTIVE TAPE
⚙️ GEARS	30	👉 SADDLE	SELLE ROYAL ARIEL HRC GEL
📖 WEIGHT	18,6 KG	💡 LIGHT	AXA PICO30 W/ STANDLIGHT / SLIM W/ STANDLIGHT

ARTICLE NUMBER
30200370

COLOR	
  	30200370A



HEAD SET: FSA TH807ST THREADED 1 1/8" | STEM: GEPIDA MQ-565 EXT: 85/105MM BB: 25,4MM | HANDLE BAR: GEPIDA ALLOY AL-155TP W: 640MM BB: 25,4MM | GRIP: VELO VLG-649 AD2 | BRAKE LEVER: SHIMANO ACERA BL-M395 | BRAKE DISC F/R: SHIMANO RT-56S 160MM | SHIFTING LEVER: SHIMANO DEORE SL-T6000 3X10S | SEAT POST: KALLOY SP-509 27,2X300MM | CRANKSET: SHIMANO DEORE FC-T521 48-36-26T 170/175MM | BOTTOM BRACKET: SHIMANO BB-ES300 OCTALINK 121MM | CASSETTE/COG: SHIMANO TIAGRA CS-HG500-10 11-34T 10S | CHAIN: SHIMANO DEORE CN-HG54 10S | RIM: RODI EXCALIBUR XC 28", 32H | FRONT HUB: SHIMANO DH-3D32 QR 32H | REAR HUB: FORMULA DC-22 QR 32H | SPOKE: SAPIM STAINLESS BLACK | RACK: MASSLOAD CL-550 | MUDGUARD: SKS | CHAIN COVER: - | PEDAL: XERAMA SP-811 ALLOY W/ CATEYE

ALBOIN 500



△ FRAME	GEPIDA HYDROFORMING - 6061 ALLOY	🛞 BRAKE	SHIMANO ALTUS BR-M365
△ FRAME SIZE	48, 52, 56CM	👉 FRONT DERAILLEUR	SHIMANO ACERA FD-T3000 TOP SWING DUAL PULL 31,8MM
○ WHEEL SIZE	28"	👉 REAR DERAILLEUR	SHIMANO DEORE RD-M592 SHADOW
⌒ FORK	SUNTOUR NEX DS 700C HLO 63MM	🌀 TYRE	SCHWALBE SILENTO KEVLARGUARD 42-622 W/ REFELCTIVE TAPE
⚙️ GEARS	27	👉 SADDLE	SELLE ROYAL ARIEL HRC GEL
📖 WEIGHT	17,2 KG	💡 LIGHT	AXA PICO15 / SLIM W/ STANDLIGHT

ARTICLE NUMBER
30200350

COLOR	
  	30200350A

HEAD SET: FSA TH807ST THREADED 1 1/8" | STEM: GEPIDA MTS-C297 EXT: 90/110MM BB: 25,4MM | HANDLE BAR: GEPIDA ALLOY AL-155TP W: 640MM BB: 25,4MM | GRIP: VELO VLG-519A | BRAKE LEVER: SHIMANO ALTUS BL-M365 | BRAKE DISC F/R: SHIMANO RT-56S 160MM | SHIFTING LEVER: SHIMANO ACERA SL-M3000 3X9S | SEAT POST: KALLOY SP-509 27,2X300MM | CRANKSET: SUNTOUR XCM-T418 OC 48-36-26T 170/175MM | BOTTOM BRACKET: SHIMANO BB-ES300 OCTALINK 113MM | CASSETTE/COG: SHIMANO ACERA CS-HG201 11-32T 9S | CHAIN: SHIMANO CN-HG53 9S | RIM: RODI EXCALIBUR XC 28", 32H | FRONT HUB: SHIMANO DH-3D32 QR 32H | REAR HUB: FORMULA DC-22 QR 32H | SPOKE: SAPIM STAINLESS BLACK | RACK: MASSLOAD CL-550 | MUDGUARD: SKS | CHAIN COVER: - | PEDAL: XERAMA SP-811 ALLOY W/ CATEYE

ALBOIN 500 LS



△ FRAME	GEPIDA HYDROFORMING - 6061 ALLOY	👤 BRAKE	SHIMANO ALTUS BR-M365
△ FRAME SIZE	44, 48, 52CM	👤 FRONT DERAILLEUR	SHIMANO ACERA FD-T3000 TOP SWING DUAL PULL 31,8MM
○ WHEEL SIZE	28"	👤 REAR DERAILLEUR	SHIMANO DEORE RD-M592 SHADOW
⌒ FORK	SUNTOUR NEX DS 700C HLO 63MM	🌀 TYRE	SCHWALBE SILENTO KEVLARGUARD 42-622 W/ REFELCTIVE TAPE
⚙️ GEARS	27	👤 SADDLE	SELLE ROYAL ARIEL DRC
📖 WEIGHT	17,2 KG	👤 LIGHT	AXA PICO15 / SLIM W/ STANDLIGHT

ARTICLE NUMBER
30200356

COLOR	
	30200356A

HEAD SET: FSA TH807ST THREADED 1 1/8" | STEM: GEPIDA MTS-C297 EXT: 90MM BB: 25,4MM | HANDLE BAR: GEPIDA ALLOY AL-155TP W: 640MM BB: 25,4MM | GRIP: VELO VLG-519A | BRAKE LEVER: SHIMANO ALTUS BL-M365 | BRAKE DISC F/R: SHIMANO RT-56S 160MM | SHIFTING LEVER: SHIMANO ACERA SL-M3000 3X9S | SEAT POST: KALLOY SP-509 27,2X300MM | CRANKSET: SUNTOUR XCM-T418 OC 48-36-26T 170/175MM | BOTTOM BRACKET: SHIMANO BB-ES300 OCTALINK 113MM | CASSETTE/COG: SHIMANO ACERA CS-HG201 11-32T 9S | CHAIN: SHIMANO CN-HG53 9S | RIM: RODI EXCALIBUR XC 28" , 32H | FRONT HUB: SHIMANO DH-3D32 QR 32H | REAR HUB: FORMULA DC-22 QR 32H | SPOKE: SAPIM STAINLESS BLACK | RACK: MASSLOAD CL-550 | MUDGUARD: SKS | CHAIN COVER: - | PEDAL: XERAMA SP-811 ALLOY W/ CATEYE

ALBOIN 300 PRO



△ FRAME	6061 ALLOY	👤 BRAKE	SHIMANO ALTUS BR-M315
△ FRAME SIZE	48, 52, 56, 60CM	👤 FRONT DERAILLEUR	SHIMANO TY FD-TY710 TOP SWING DUAL PULL 31,8MM
○ WHEEL SIZE	28"	👤 REAR DERAILLEUR	SHIMANO ALIVIO RD-T4000 SCS
⌒ FORK	SUNTOUR NEX DS 700C HLO 63MM	🌀 TYRE	WTB/FREEDOM WEDGE 700X38C W/ REFELCTIVE TAPE
⚙️ GEARS	24	👤 SADDLE	SELLE ROYAL ALPINE HRC
📖 WEIGHT	17,2 KG	👤 LIGHT	AXA PICO15 / SLIM W/ STANDLIGHT

ARTICLE NUMBER
30200340

COLOR	
	30200340A

HEAD SET: FSA TH807ST THREADED 1 1/8" | STEM: GEPIDA MTS-C297 EXT: 110MM BB: 25,4MM | HANDLE BAR: GEPIDA ALLOY AL-155TP W: 640MM BB: 25,4MM | GRIP: VELO VLG-519A | BRAKE LEVER: SHIMANO ALTUS BL-M315 | BRAKE DISC F/R: SHIMANO RT-26S 160MM | SHIFTING LEVER: SHIMANO ALTUS SL-M310 3X8S | SEAT POST: KALLOY SP-509 27,2X300MM | CRANKSET: SUNTOUR XCC-T208 48-38-28T 170/175MM | BOTTOM BRACKET: SHIMANO BB-UN100-K 122,5MM | CASSETTE/COG: SHIMANO ALTUS CS-HG31 11-32T 8S | CHAIN: KMC Z72 8S | RIM: BERETTA DISC25 622X19 | FRONT HUB: SHIMANO DH-3D32 QR 32H | REAR HUB: FORMULA DC-22 QR 32H | SPOKE: SAPIM STEEL BLACK | RACK: MASSLOAD CL550 | MUDGUARD: SKS | CHAIN COVER: | PEDAL: XERAMA SP-940 PP/STEEL W/ CATYE

ALBOIN 300 M



△ FRAME	6061 ALLOY	🚒 BRAKE	SHIMANO ALIVIO BR-T4000 V-BRAKE
△ FRAME SIZE	48, 52, 56, 60CM	🚲 FRONT DERAILLEUR	SHIMANO TY FD-TY710 TOP SWING DUAL PULL 31,8MM
○ WHEEL SIZE	28"	🚲 REAR DERAILLEUR	SHIMANO ALIVIO RD-T4000 SGS
⌒ FORK	SUNTOUR CR8 700C HL TRAVEL: 50 MM	🚲 TYRE	WTB/FREEDOM WEDGE 700X38C W/ REFELCTIVE TAPE
⚙️ GEARS	24	🚲 SADDLE	SELLE ROYAL ALPINE HRC
📖 WEIGHT	17,9 KG	💡 LIGHT	AXA PICO15 / SLIM W/ STANDLIGHT

ARTICLE NUMBER
30200330

COLOR		
	30200330A	
	30200330B	

HEAD SET: FSA TH807ST THREADED 1 1/8" | STEM: GEPIDA MTS-C297 EXT: 110MM BB: 25,4MM | HANDLE BAR: GEPIDA ALLOY AL-155TP W: 640MM BB: 25,4MM | GRIP: VELO VLG-519A | BRAKE LEVER: SHIMANO ALTUS ST-EF510 4FINGER | BRAKE DISC F/R: - | SHIFTING LEVER: SHIMANO ALTUS ST-EF510 3X8S | SEAT POST: KALLOY SP-509 27,2X300MM | CRANKSET: SUNTOUR XCC-T208 48-38-28T 170/175MM | BOTTOM BRACKET: SHIMANO BB-UN100-K 122,5MM | CASSETTE/COG: SHIMANO ALTUS CS-HG31 11-32T 8S | CHAIN: KMC Z72 8S | RIM: RODI SKORPION CNC 28" 32H | FRONT HUB: SHIMANO DH-C3000-3N 6V 3W 32H | REAR HUB: FORMULA FM32 QR 32H | SPOKE: SAPIM STEEL BLACK | RACK: MASSLOAD CL-550 | MUDGUARD: SKS | CHAIN COVER: - | PEDAL: XERAMA SP-940 PP/STEEL W/ CATYE

ALBOIN 300 LS



△ FRAME	6061 ALLOY	🚒 BRAKE	SHIMANO ALIVIO BR-T4000 V-BRAKE
△ FRAME SIZE	44, 48, 52CM	🚲 FRONT DERAILLEUR	SHIMANO TY FD-TY710 TOP SWING DUAL PULL 31,8MM
○ WHEEL SIZE	28"	🚲 REAR DERAILLEUR	SHIMANO ALIVIO RD-T4000 SGS
⌒ FORK	SUNTOUR CR8 700C HL TRAVEL: 50 MM	🚲 TYRE	WTB/FREEDOM WEDGE 700X38C W/ REFELCTIVE TAPE
⚙️ GEARS	24	🚲 SADDLE	SELLE ROYAL ALPINE DRC
📖 WEIGHT	17,9 KG	💡 LIGHT	AXA PICO15 / SLIM W/ STANDLIGHT

ARTICLE NUMBER
30200336

COLOR		
	30200336A	
	30200336B	

HEAD SET: FSA TH807ST THREADED 1 1/8" | STEM: GEPIDA MTS-C297 EXT: 110MM BB: 25,4MM | HANDLE BAR: GEPIDA ALLOY AL-155TP W: 640MM BB: 25,4MM | GRIP: VELO VLG-519A | BRAKE LEVER: SHIMANO ALTUS ST-EF510 4FINGER | BRAKE DISC F/R: - | SHIFTING LEVER: SHIMANO ALTUS ST-EF510 3X8S | SEAT POST: KALLOY SP-509 27,2X300MM | CRANKSET: SUNTOUR XCC-T208 48-38-28T 170/175MM | BOTTOM BRACKET: SHIMANO BB-UN100-K 122,5MM | CASSETTE/COG: SHIMANO ALTUS CS-HG31 11-32T 8S | CHAIN: KMC Z72 8S | RIM: RODI SKORPION CNC 28" 32H | FRONT HUB: SHIMANO DH-C3000-3N 6V 3W 32H | REAR HUB: FORMULA FM32 QR 32H | SPOKE: SAPIM STEEL BLACK | RACK: MASSLOAD CL-550 | MUDGUARD: SKS | CHAIN COVER: - | PEDAL: XERAMA SP-940 PP/STEEL W/ CATYE

ALBOIN 300 W



△ FRAME	6061 ALLOY	🚫 BRAKE	SHIMANO ALIVIO BR-T4000 V-BRAKE
△ FRAME SIZE	45, 50, 55CM	🚲 FRONT DERAILLEUR	SHIMANO TY FD-TY710 TOP SWING DUAL PULL 31,8MM
○ WHEEL SIZE	28"	🚲 REAR DERAILLEUR	SHIMANO ALIVIO RD-T4000 SGS
⌒ FORK	SUNTOUR CR8 700C HL TRAVEL: 50 MM	🚲 TYRE	WTB/FREEDOM WEDGE 700X38C W/ REFELCTIVE TAPE
⚙️ GEARS	24	🚲 SADDLE	SELLE ROYAL ALPINE DRC
📖 WEIGHT	17,9 KG	💡 LIGHT	AXA PICO15 / SLIM W/ STANDLIGHT

ARTICLE NUMBER

30200335

COLOR

 30200335A	 30200335B
---	---

HEAD SET: FSA TH807ST THREADED 1 1/8" | STEM: CEPIDA MTS-C297 EXT: 110MM BB: 25,4MM | HANDLE BAR: CEPIDA ALLOY AL-155TP W: 640MM BB: 25,4MM | GRIP: VELO VLG-519A | BRAKE LEVER: SHIMANO ALTUS ST-EF510 4FINGER | BRAKE DISC F/R: - | SHIFTING LEVER: SHIMANO ALTUS ST-EF510 3X8S | SEAT POST: KALLOY SP-509 27,2X300MM | CRANKSET: SUNTOUR XCC-T208 48-38-28T 170/175MM | BOTTOM BRACKET: SHIMANO BB-UN100-K 122,5MM | CASSETTE/COG: SHIMANO ALTUS CS-HG31 11-32T 8S | CHAIN: KMC Z72 8S | RIM: RODI SKORPION CNC 28" 32H | FRONT HUB: SHIMANO DH-C3000-3N 6V 3W 32H | REAR HUB: FORMULA FM32 QR 32H | SPOKE: SAPIM STEEL BLACK | RACK: MASSLOAD CL-550 | MUDGUARD: SKS | CHAIN COVER: - | PEDAL: XERAMA SP-940 PP/STEEL W/ CATYE

ALBOIN 200 PRO M



△ FRAME	6061 ALLOY	🚫 BRAKE	GEPIDA TX-117 V-BRAKE
△ FRAME SIZE	48, 52, 56CM	🚲 FRONT DERAILLEUR	SHIMANO TY FD-TY510 TOP SWING DUAL PULL 31,8MM
○ WHEEL SIZE	28"	🚲 REAR DERAILLEUR	SHIMANO ACERA RD-M360 SGS 7/8S
⌒ FORK	SUNTOUR M3010 700C 63MM	🚲 TYRE	WTB/FREEDOM SCORCHER 700X38C
⚙️ GEARS	21	🚲 SADDLE	SELLE ROYAL ALPINE HRC
📖 WEIGHT	17,2 KG	💡 LIGHT	AXA ECHO15 / X-RAY W/ STANDLIGHT

ARTICLE NUMBER

30200320

COLOR

 30200320A	 30200320B
---	---

HEAD SET: FSA TH807ST THREADED 1 1/8" | STEM: CEPIDA MQ-417 EXT: 80MM BB: 25,4MM | HANDLE BAR: CEPIDA STEEL 155TP W: 640MM RISE: 30MM BB: 25,4MM | GRIP: VELO VLG-519A | BRAKE LEVER: SHIMANO ST-EF 41 | BRAKE DISC F/R: - | SHIFTING LEVER: SHIMANO ST-EF 41 3X7S | SEAT POST: GEPIDA ALLOY SP-C207 27,2X300MM | CRANKSET: SUNTOUR XCC-T208 48-38-28T 170/175MM | BOTTOM BRACKET: SHIMANO BB-UN100 122,5MM | CASSETTE/COG: SHIMANO MF-TZ500 14-28T 7S | CHAIN: KMC Z50 | RIM: BERETTA MT240E 28" 36H | FRONT HUB: SHIMANO DH-C3000-3N 6V 3W 36H | REAR HUB: FORMULA FM31 36H | SPOKE: STEEL | RACK: STEEL | MUDGUARD: ORION BLACK | CHAIN COVER: - | PEDAL: XERAMA SP872N PP

ALBOIN 200 PRO LS



△ FRAME	6061 ALLOY	🚲 BRAKE	GEPIDA TX-117 V-BRAKE
△ FRAME SIZE	44, 48, 52CM	🚲 FRONT DERAILLEUR	SHIMANO TY FD-TY510 TOP SWING DUAL PULL 31,8MM
○ WHEEL SIZE	28"	🚲 REAR DERAILLEUR	SHIMANO ACERA RD-M360 SGS 7/8S
⌒ FORK	SUNTOUR M3010 700C 63MM	🚲 TYRE	WTB/FREEDOM SCORCHER 700X38C
⚙️ GEARS	21	🚲 SADDLE	SELLE ROYAL ALPINE DRC
📖 WEIGHT	17,2 KG	🚲 LIGHT	AXA ECHO15 / X-RAY W/ STANDLIGHT
ARTICLE NUMBER		COLOR	
30200326		🚲 30200326A	🚲 30200326B

HEAD SET: FSA TH807ST THREADED 1 1/8" | STEM: GEPIDA MQ-417 EXT: 80MM BB: 25,4MM | HANDLE BAR: GEPIDA STEEL 155TP W: 640MM RISE: 30MM BB: 25,4MM | GRIP: VELO VLG-519A | BRAKE LEVER: SHIMANO ST-EF 41 | BRAKE DISC F/R: - | SHIFTING LEVER: SHIMANO ST-EF 41 3X7S | SEAT POST: GEPIDA ALLOY SP-C207 27,2X300MM | CRANKSET: SUNTOUR XCC-T208 48-38-28T 170/175MM | BOTTOM BRACKET: SHIMANO BB-UN100 122,5MM | CASSETTE/COG: SHIMANO MF-TZ500 14-28T 7S | CHAIN: KMC Z50 | RIM: BERETTA MT240E 28" 36H | FRONT HUB: SHIMANO DH-C3000-3N 6V 3W 36H | REAR HUB: FORMULA FM31 36H | SPOKE: STEEL | RACK: STEEL | MUDGUARD: ORION BLACK | CHAIN COVER: - | PEDAL: XERAMA SP872N PP

ALBOIN 200 M









△ FRAME	6061 ALLOY	🚲 BRAKE	GEPIDA TX-117 V-BRAKE
△ FRAME SIZE	M: 48, 52, 56 CM L: 44, 48, 52 CM	🚲 FRONT DERAILLEUR	SHIMANO TY FD-TY510 TOP SWING DUAL PULL 31,8MM
○ WHEEL SIZE	28"	🚲 REAR DERAILLEUR	SHIMANO TY RD-TY300D
⌒ FORK	ZOOM ENJOY 123 E 40 MM	🚲 TYRE	WTB/FREEDOM SCORCHER 700X38C
⚙️ GEARS	21	🚲 SADDLE	SELLE ROYAL ALPINE HRC
📖 WEIGHT	17,3 KG	🚲 LIGHT	BÜCHEL UNILED 15 / AXA X-RAY W/ STANDLIGHT
ARTICLE NUMBER		COLOR	
30200310		🚲 30200310A	🚲 30200310B

HEAD SET: FSA TH807ST THREADED 1 1/8" | STEM: GEPIDA MQ-417 EXT: 80MM BB: 25,4MM | HANDLE BAR: GEPIDA STEEL 155TP W: 640MM RISE: 30MM BB: 25,4MM | GRIP: VELO VLG-207 KRATON | BRAKE LEVER: SHIMANO ST-EF 41 | BRAKE DISC F/R: - | SHIFTING LEVER: SHIMANO ST-EF 41 3X7S | SEAT POST: GEPIDA ALLOY SP-C207 27,2X300MM | CRANKSET: PROWHELL A541 28-38-48/170 MM | BOTTOM BRACKET: PROWHELL A541 48-38-28T 170MM | CASSETTE/COG: SHIMANO MF-TZ500 14-28T 7S | CHAIN: KMC Z50 | RIM: BERETTA MT240E 28" 36H | FRONT HUB: SHIMANO DH-C3000-3N 6V 3W 36H | REAR HUB: FORMULA FM31 36H | SPOKE: STEEL | RACK: STEEL | MUDGUARD: ORION BLACK | CHAIN COVER: - | PEDAL: XERAMA SP872N PP

ALBOIN 200 W











△ FRAME	6061 ALLOY	🔒 BRAKE	GEPIDA TX-117 V-BRAKE
△ FRAME SIZE	44, 48, 52CM	👉 FRONT DERAILLEUR	SHIMANO TY FD-TY510 TOP SWING DUAL PULL 31,8MM
○ WHEEL SIZE	28"	👉 REAR DERAILLEUR	SHIMANO TY RD-TY300D
⌒ FORK	ZOOM ENJOY 123 E 40 MM	🌀 TYRE	WTB/FREEDOM SCORCHER 700X38C
⚙️ GEARS	21	👉 SADDLE	SELLE ROYAL ALPINE DRC
📖 WEIGHT	17,3 KG	💡 LIGHT	BÜCHEL UNILED 15 / AXA X-RAY W/ STANDLIGHT
ARTICLE NUMBER	30200316		
	COLOR		
	   30200316A	   30200316B	

HEAD SET: FSA TH807ST THREADED 1 1/8" | STEM: GEPIDA MQ-417 EXT: 80MM BB: 25,4MM | HANDLE BAR: GEPIDA STEEL 155TP W: 640MM RISE: 30MM BB: 25,4MM | GRIP: VELO VLG-207 KRATON | BRAKE LEVER: SHIMANO ST-EF 41 | BRAKE DISC F/R: - | SHIFTING LEVER: SHIMANO ST-EF 41 3X7S | SEAT POST: GEPIDA ALLOY SP-C207 27,2X300MM | CRANKSET: PROWHELL A541 28-38-48/170 MM | BOTTOM BRACKET: PROWHEEL A541 48-38-28T 170MM | CASSETTE/COG: SHIMANO MF-TZ500 14-28T 7S | CHAIN: KMC Z50 | RIM: BERETTA MT240E 28" 36H | FRONT HUB: SHIMANO DH-C3000-3N 6V 3W 36H | REAR HUB: FORMULA FM31 36H | SPOKE: STEEL | RACK: STEEL | MUDGUARD: ORION BLACK | CHAIN COVER: - | PEDAL: XERAMA SP872N PP

ALBOIN 100 M



△ FRAME	STEEL	🔒 BRAKE	GEPIDA TX-117 V-BRAKE
△ FRAME SIZE	52, 56CM	👉 FRONT DERAILLEUR	SHIMANO TY FD-TY510 TOP SWING DUAL PULL 28,6MM
○ WHEEL SIZE	28"	👉 REAR DERAILLEUR	SHIMANO TY RD-TY300D
⌒ FORK	STEEL	🌀 TYRE	WTB/FREEDOM SCORCHER 700X38C
⚙️ GEARS	21	👉 SADDLE	SELLE ROYAL ALPINE HRC
📖 WEIGHT	17,2 KG	💡 LIGHT	BÜCHEL KB 50/75 HALOGEN / X-RAY W/ STANDLIGHT
ARTICLE NUMBER	30200300		
	COLOR		
	   30200300A	   30200300B	   30200300C

HEAD SET: STEEL BLACK | STEM: GEPIDA LS120 EXT: 80MM BB: 25,4MM | HANDLE BAR: GEPIDA STEEL 155TP W: 640MM RISE: 30MM BB: 25,4MM | GRIP: VELO VLG-207 KRATON | BRAKE LEVER: LOGAN 327AE ALLOY 4 FINGER | BRAKE DISC F/R: - | SHIFTING LEVER: SHIMANO TY SL-RS35 REVOSHIFT 3X7S | SEAT POST: GEPIDA SP-501S STEEL 25,4X300MM | CRANKSET: PROWHELL A541 48-38-28T 170MM | BOTTOM BRACKET: THUN BASIC PLUS 128MM | CASSETTE/COG: SHIMANO MF-TZ500 14-28T 7S | CHAIN: KMC Z50 | RIM: BERETTA MT240E 28" 36H | FRONT HUB: FORMULA FM21 36H | REAR HUB: FORMULA FM31 36H | SPOKE: STEEL | RACK: STEEL | MUDGUARD: ORION BLACK | CHAIN COVER: - | PEDAL: XERAMA SP872N PP

ALBOIN 100 W



△ FRAME	STEEL	🔒 BRAKE	GEPIDA TX-117 V-BRAKE
△ FRAME SIZE	46CM	👉 FRONT DERAILLEUR	SHIMANO TY FD-TY510 TOP SWING DUAL PULL 28,6MM
○ WHEEL SIZE	28"	👉 REAR DERAILLEUR	SHIMANO TY RD-TY300D
⌒ FORK	STEEL	🌀 TYRE	WTB/FREEDOM SCORCHER 700X38C
⚙️ GEARS	21	📖 SADDLE	SELLE ROYAL ALPINE DRC
📖 WEIGHT	17,2 KG	💡 LIGHT	BÜCHEL KB 50/75 HALOGEN / X-RAY W/ STANDLIGHT
ARTICLE NUMBER	30200306		
COLOR	30200306A	30200306B	

HEAD SET: STEEL BLACK | STEM: GEPIDA LS120 EXT: 80MM BB: 25,4MM | HANDLE BAR: GEPIDA STEEL 155TP W: 640MM RISE: 30MM BB: 25,4MM | GRIP: VELO VLC-207 KRATON | BRAKE LEVER: LOGAN 327AE ALLOY 4 FINGER | BRAKE DISC F/R: - | SHIFTING LEVER: SHIMANO TY SL-RS35 REVOSHIFT 3X7S | SEAT POST: GEPIDA SP-501S STEEL 25,4X300MM | CRANKSET: PROWHEEL A541 48-38-28T 170MM | BOTTOM BRACKET: THUN BASIC PLUS 128MM | CASSETTE/COG: SHIMANO MF-TZ500 14-28T 7S | CHAIN: KMC Z50 | RIM: BERETTA MT240E 28" 36H | FRONT HUB: FORMULA FM21 36H | REAR HUB: FORMULA FM31 36H | SPOKE: STEEL | RACK: STEEL | MUDGUARD: ORION BLACK | CHAIN COVER: - | PEDAL: XERAMA SP872N PP

We believe that the bicycles we offer become companions, a part of bikers' lives. It doesn't matter if you go to work by bike as usual or on a trip with your family or friends, or if you take the unknown path with new experiences and challenges.





CROSS

ASPHALT OR DIRT ROAD? WHY NOT?

This bike combines the characteristics of sports and trekking bikes, moreover, it can handle easy terrains as well, and it is faster on asphalt than mountain bikes. The geometry and the rolling resistance are important aspects, this way you can exploit your capacity. One of its greatest assets is that it is equally suitable for weekdays, on your way to work and at the weekend for light trips as well.

CROSS BICYCLES

ALBOIN 900 CRS



△ FRAME	GEPIDA HYDROFORMING - 6061 ALLOY	🛞 BRAKE	SHIMANO ACERA BR-M395
△ FRAME SIZE	48, 52, 56CM	👣 FRONT DERAILLEUR	SHIMANO DEORE FD-T6000 TOP SWING DUAL PULL 31,8MM
○ WHEEL SIZE	28"	👣 REAR DERAILLEUR	SHIMANO XT RDT8000 SGS SHADOW
⌒ FORK	SUNTOUR NCX-D 700C LO 63MM	🛞 TYRE	SCHWALBE SPICER 40-622 W/ REFLECTIVE TAPE
⚙️ GEARS	30	👣 SADDLE	SELLE ROYAL DARDO GEL HRC
📦 WEIGHT	14,2 KG	💡 LIGHT	-

ARTICLE NUMBER
30200290

COLOR
 **30200290A**

HEAD SET: FSA NO.11N | STEM: GEPIDA/TRANZX JDST-58A EXT: 80/90/100MM | HANDLE BAR: GEPIDA ALLOY MTB AL-118 600MM BB: 31,8MM | GRIP: VELO VLG-1185D3 | BRAKE LEVER: SHIMANO ACERA BL-M425 | BRAKE DISC F/R: SHIMANO RT-56S 180MM | SHIFTING LEVER: SHIMANO LX SL-T670 3X10S | SEAT POST: GEPIDA ALLOY SP-226 27.2X300 MM | CRANKSET: SHIMANO LX FC-T551 48-36-26T 170/175MM | BOTTOM BRACKET: SHIMANO SM-BB52 INTEGRATED | CASSETTE/COG: SHIMANO TIAGRA CS-HG500-10 11-34T 10S | CHAIN: SHIMANO DEORE CN-HG54 10S | RIM: RODI EXCALIBUR XC 28" , 32H | FRONT HUB: FORMULA DC-20LW QR 32H | REAR HUB: FORMULA DC-22W QR 32H | SPOKE: SAPIM STAINLESS BLACK | RACK: - | MUDGUARD: - | CHAIN COVER: - | PEDAL: XERAMA SP-610 ALLOY W/ CATEYE

ALBOIN 700 CRS



△ FRAME	GEPIDA HYDROFORMING - 6061 ALLOY	🔒 BRAKE	SHIMANO ACERA BR-M396
△ FRAME SIZE	48, 52, 56CM	👉 FRONT DERAILLEUR	SHIMANO DEORE FD-T6000 TOP SWING DUAL PULL 31,8MM
○ WHEEL SIZE	28"	👉 REAR DERAILLEUR	SHIMANO RD-T6000, DEORE, SGS 10SPEED, SHADOW DESIGN
⌒ FORK	SUNTOUR NCX-D 700C LO 63MM	🌀 TYRE	SCHWALBE SMART SAM 700X40C
⚙️ GEARS	30	📅 SADDLE	SELLE ROYAL DARDO GEL HRC
📦 WEIGHT	14,1 KG	💡 LIGHT	-

ARTICLE NUMBER
30200270

COLOR	
	30200270A

HEAD SET: FSA NO.11N | STEM: GEPIDA/TRANZX JDST-58A EXT: 70/80/90MM | HANDLE BAR: GEPIDA ALLOY MTB AL-118 600MM BB: 31,8MM | GRIP: VELO VLG-1185D3 | BRAKE LEVER: SHIMANO ACERA BL-M395 | BRAKE DISC F/R: SHIMANO RT-56S 180MM | SHIFTING LEVER: SHIMANO DEORE SL-T6000 3X10S | SEAT POST: GEPIDA ALLOY SP-226 27.2X300 MM | CRANKSET: SHIMANO DEORE FC-T521 48-36-26T 170/175MM | BOTTOM BRACKET: SHIMANO BB-ES300 OCTALINK 121MM | CASSETTE/COG: SHIMANO TIAGRA CS-HG500-10 11-34T 10S | CHAIN: SHIMANO DEORE CN-HG54 10S | RIM: RODI EXCALIBUR XC 28", 32H | FRONT HUB: FORMULA DC-20LW QR 32H | REAR HUB: FORMULA DC-22W QR 32H | SPOKE: SAPIM STAINLESS BLACK | RACK: - | MUDGUARD: - | CHAIN COVER: - | PEDAL: XERAMA SP-610 ALLOY W/ CATEYE

ALBOIN 500 CRS



△ FRAME	GEPIDA HYDROFORMING - 6061 ALLOY	🔒 BRAKE	SHIMANO ALTUS BR-M365
△ FRAME SIZE	48, 52, 56CM	👉 FRONT DERAILLEUR	SHIMANO ACERA FD-T3000 TOP SWING DUAL PULL 31,8MM
○ WHEEL SIZE	28"	👉 REAR DERAILLEUR	SHIMANO DEORE RD-M592 SHADOW
⌒ FORK	SUNTOUR NEX DS 700C HLO 63MM	🌀 TYRE	SCHWALBE CX COMP 40-622
⚙️ GEARS	27	📅 SADDLE	SELLE ROYAL DARDO HRC
📦 WEIGHT	15,1 KG	💡 LIGHT	-

ARTICLE NUMBER
30200250

COLOR	
	30200250A

HEAD SET: FSA NO.11N | STEM: GEPIDA/TRANZX JDST-58A EXT: 80/90/100MM | HANDLE BAR: GEPIDA ALLOY MTB AL-118 600MM BB: 31,8MM | GRIP: VELO VLG-1185D3 | BRAKE LEVER: SHIMANO ALTUS BL-M365 | BRAKE DISC F/R: SHIMANO RT-56S 160MM | SHIFTING LEVER: SHIMANO ACERA SL-M3000 3X9S | SEAT POST: GEPIDA ALLOY SP-226 27.2X300 MM | CRANKSET: SUNTOUR XCM-T418 OC 48-36-26T 170/175MM | BOTTOM BRACKET: SHIMANO BB-ES300 OCTALINK 113MM | CASSETTE/COG: SHIMANO ACERA CS-HG201 11-32T 9S | CHAIN: SHIMANO CN-HG53 9S | RIM: RODI EXCALIBUR XC 28", 32H | FRONT HUB: FORMULA DC-20 QR 32H | REAR HUB: FORMULA DC-22 QR 32H | SPOKE: SAPIM STAINLESS BLACK | RACK: - | MUDGUARD: - | CHAIN COVER: - | PEDAL: XERAMA SP-610 ALLOY W/ CATEYE

ALBOIN 300 PRO CRS



△ FRAME	6061 ALLOY	🛞 BRAKE	SHIMANO ALTUS BR-M315
△ FRAME SIZE	48, 52, 56 60CM	👉 FRONT DERAILLEUR	SHIMANO TY FD-TY710 TOP SWING DUAL PULL 34,9MM
○ WHEEL SIZE	28"	👉 REAR DERAILLEUR	SHIMANO ALIVIO RD-T4000 SGS
⌒ FORK	SUNTOUR NEX 700C HLO 63MM	🌀 TYRE	WTB/FREEDOM WEDGE 700X38C
⚙️ GEARS	24	📵 SADDLE	SELLE ROYAL ALPINE HRC
📖 WEIGHT	14,9 KG	💡 LIGHT	-

ARTICLE NUMBER
30200240

COLOR	
  	30200240A

HEAD SET: FSA NO.11Q | STEM: KALLOY ASDC1 EXT: 90MM | HANDLE BAR: GEPIDA ALLOY AL-118 W: 600MM BB: 31,8MM | GRIP: VELO VLG-1185D3 | BRAKE LEVER: SHIMANO ALTUS BL-M315 | BRAKE DISC F/R: SHIMANO RT-26S 160MM | SHIFTING LEVER: SHIMANO ALTUS SL-M310 3X8S | SEAT POST: GEPIDA ALLOY SP-C207 27,2X300MM | CRANKSET: SUNTOUR XCC-T208 48-38-28T 170/175MM | BOTTOM BRACKET: SHIMANO BB-UN100 122,5MM | CASSETTE/COG: SHIMANO ALTUS CS-HG31 11-32T 8S | CHAIN: KMC Z72 8S | RIM: BERETTA DISC25 622X19 | FRONT HUB: FORMULA DC-20 QR 32H | REAR HUB: FORMULA DC-22 QR 32H | SPOKE: SAPIM STEEL BLACK | RACK: - | MUDGUARD: - | CHAIN COVER: - | PEDAL: XERAMA SP-940 PP/STEEL W/ CATYE

ALBOIN 300 CRS M



△ FRAME	6061 ALLOY	🛞 BRAKE	SHIMANO ALIVIO BR-T4000 V-BRAKE
△ FRAME SIZE	48, 52, 56, 60CM	👉 FRONT DERAILLEUR	SHIMANO TY FD-TY710 TOP SWING DUAL PULL 34,9MM
○ WHEEL SIZE	28"	👉 REAR DERAILLEUR	SHIMANO ALIVIO RD-T4000 SGS
⌒ FORK	SUNTOUR CR8 700C 50MM HLO	🌀 TYRE	WTB/FREEDOM WEDGE 700X38C
⚙️ GEARS	24	📵 SADDLE	SELLE ROYAL ALPINE HRC
📖 WEIGHT	14,3 KG	💡 LIGHT	-

ARTICLE NUMBER
30200230

COLOR		
 	30200230A	 
		30200230B

HEAD SET: FSA NO.11Q | STEM: KALLOY ASDC1 EXT: 90MM | HANDLE BAR: GEPIDA ALLOY AL-118 W: 600MM BB: 31,8MM | GRIP: VELO VLG-1185D3 | BRAKE LEVER: SHIMANO ALTUS ST-EF510 2FINGER | BRAKE DISC F/R: - | SHIFTING LEVER: SHIMANO ALTUS ST-EF510 3X8S | SEAT POST: GEPIDA ALLOY SP-C207 27,2X300MM | CRANKSET: SUNTOUR XCC-T208 48-38-28T 170/175MM | BOTTOM BRACKET: SHIMANO BB-UN100 122,5MM | CASSETTE/COG: SHIMANO ALTUS CS-HG31 11-32T 8S | CHAIN: KMC Z72 8S | RIM: RODI SKORPION CNC 28" 32H | FRONT HUB: FORMULA FM21 QR 32H | REAR HUB: FORMULA RB30 QR 32H | SPOKE: SAPIM STEEL BLACK | RACK: - | MUDGUARD: - | CHAIN COVER: - | PEDAL: XERAMA SP-940 PP/STEEL W/ CATYE

ALBOIN 300 CRS LS



△ FRAME	6061 ALLOY	🚒 BRAKE	SHIMANO ALIVIO BR-T4000 V-BRAKE
△ FRAME SIZE	44, 48, 52CM	🚶 FRONT DERAILLEUR	SHIMANO TY FD-TY710 TOP SWING DUAL PULL 34,9MM
○ WHEEL SIZE	28"	🚶 REAR DERAILLEUR	SHIMANO ALIVIO RD-T4000 SGS
⌒ FORK	SUNTOUR CR8 700C 50MM HLO	🚶 TYRE	WTB/FREEDOM WEDGE 700X38C
⚙️ GEARS	24	🚶 SADDLE	SELLE ROYAL ALPINE DRC
📖 WEIGHT	14,3 KG	🚶 LIGHT	-

ARTICLE NUMBER
30200236

COLOR	
	30200236A

HEAD SET: FSA NO.11Q | STEM: KALLOY ASDC1 EXT: 75MM | HANDLE BAR: GEPIDA ALLOY AL-118 W: 600MM BB: 31,8MM | GRIP: VELO VLG-1185D3 | BRAKE LEVER: SHIMANO ALTUS ST-EF510 2FINGER | BRAKE DISC F/R: - | SHIFTING LEVER: SHIMANO ALTUS ST-EF510 3X8S | SEAT POST: GEPIDA ALLOY SP-C207 27,2X300MM | CRANKSET: SUNTOUR XCC-T208 48-38-28T 170/175MM | BOTTOM BRACKET: SHIMANO BB-UN100 122,5MM | CASSETTE/COG: SHIMANO ALTUS CS-HG31 11-32T 8S | CHAIN: KMC Z72 8S | RIM: RODI SKORPION CNC 28" 32H | FRONT HUB: FORMULA FM21 QR 32H | REAR HUB: FORMULA RB30 QR 32H | SPOKE: SAPIM STEEL BLACK | RACK: - | MUDGUARD: - | CHAIN COVER: - | PEDAL: XERAMA SP-940 PP/STEEL W/ CATYE

ALBOIN 200 PRO CRS



△ FRAME	6061 ALLOY	🚒 BRAKE	GEPIDA V-BRAKE TX-117
△ FRAME SIZE	48, 52, 56CM	🚶 FRONT DERAILLEUR	SHIMANO TY FD-TY510 TOP SWING DUAL PULL 34,9MM
○ WHEEL SIZE	28"	🚶 REAR DERAILLEUR	SHIMANO ACERA RD-M360 SGS 7/8S
⌒ FORK	SUNTOUR M3010 700C 63MM	🚶 TYRE	WTB/FREEDOM WEDGE 700X38C
⚙️ GEARS	21	🚶 SADDLE	SELLE ROYAL ALPINE HRC
📖 WEIGHT	14,8 KG	🚶 LIGHT	-

ARTICLE NUMBER
30200220

COLOR	
	30200220A

HEAD SET: FSA TH807ST THREADED 1 1/8" | STEM: GEPIDA MQ-417 EXT: 80MM BB: 25,4MM | HANDLE BAR: GEPIDA CROSS STEEL W: 600MM RISE: 30MM BB: 25,4MM | GRIP: VELO VLG-207 KRATON | BRAKE LEVER: SHIMANO ST-EF 41 | BRAKE DISC F/R: - | SHIFTING LEVER: SHIMANO ST-EF 41 3X7S | SEAT POST: GEPIDA ALLOY SP-C207 27,2X300MM | CRANKSET: SUNTOUR XCC-T208 48-38-28T 170/175MM | BOTTOM BRACKET: SHIMANO BB-UN100 122,5MM | CASSETTE/COG: SHIMANO MF-TZ500 14-28T 7S | CHAIN: KMC Z50 | RIM: BERETTA MT240E 28" 36H | FRONT HUB: FORMULA FM21 36H | REAR HUB: FORMULA FM31 36H | SPOKE: STEEL | RACK: - | MUDGUARD: - | CHAIN COVER: - | PEDAL: XERAMA SP872N PP

ALBOIN 200 CRS M



△ FRAME	6061 ALLOY	🚫 BRAKE	GEPIDA V-BRAKE TX-117
△ FRAME SIZE	48, 52, 56CM	🚲 FRONT DERAILLEUR	SHIMANO TY FD-TY510 TOP SWING DUAL PULL 34,9MM
○ WHEEL SIZE	28"	🚲 REAR DERAILLEUR	SHIMANO TY RD-TY300D
⌒ FORK	ZOOM ENJOY 123E 40 MM	🚲 TYRE	WTB/FREEDOM WEDGE 700X38C
⚙️ GEARS	21	🚲 SADDLE	SELLE ROYAL ALPINE HRC
📦 WEIGHT	15,1 KG	🚫 LIGHT	-

ARTICLE NUMBER
30200210

COLOR		
	30200210A	
		30200210B

HEAD SET: FSA TH807ST THREADED 1 1/8" | STEM: GEPIDA MQ-417 EXT: 80MM BB: 25,4MM | HANDLE BAR: GEPIDA CROSS STEEL W: 600MM RISE: 30MM BB: 25,4MM | GRIP: VELO VLG-207 KRATON | BRAKE LEVER: SHIMANO ST-EF 41 | BRAKE DISC F/R: - | SHIFTING LEVER: SHIMANO ST-EF 41 3X7S | SEAT POST: GEPIDA ALLOY SP-C207 27,2X300MM | CRANKSET: PROWHEEL A541 48-38-28T 170MM | BOTTOM BRACKET: SHIMANO BB-UN100 122,5MM | CASSETTE/COG: SHIMANO MF-TZ500 14-28T 7S | CHAIN: KMC Z50 | RIM: BERETTA MT240E 28" 36H | FRONT HUB: FORMULA FM21 36H | REAR HUB: FORMULA FM31 36H | SPOKE: STEEL | RACK: - | MUDGUARD: - | CHAIN COVER: - | PEDAL: XERAMA SP872N PP

ALBOIN 200 CRS W



△ FRAME	6061 ALLOY	🚫 BRAKE	GEPIDA V-BRAKE TX-117
△ FRAME SIZE	44, 48, 52CM	🚲 FRONT DERAILLEUR	SHIMANO TY FD-TY510 TOP SWING DUAL PULL 34,9MM
○ WHEEL SIZE	28"	🚲 REAR DERAILLEUR	SHIMANO TY RD-TY300D
⌒ FORK	ZOOM ENJOY 123E 40 MM	🚲 TYRE	WTB/FREEDOM WEDGE 700X38C
⚙️ GEARS	21	🚲 SADDLE	SELLE ROYAL ALPINE DRC
📦 WEIGHT	15,1 KG	🚫 LIGHT	-

ARTICLE NUMBER
30200216

COLOR		
	30200216A	
		30200216B

HEAD SET: FSA TH807ST THREADED 1 1/8" | STEM: GEPIDA MQ-417 EXT: 80MM BB: 25,4MM | HANDLE BAR: GEPIDA CROSS STEEL W: 600MM RISE: 30MM BB: 25,4MM | GRIP: VELO VLG-207 KRATON | BRAKE LEVER: SHIMANO ST-EF 41 | BRAKE DISC F/R: - | SHIFTING LEVER: SHIMANO ST-EF 41 3X7S | SEAT POST: GEPIDA ALLOY SP-C207 27,2X300MM | CRANKSET: PROWHEEL A541 48-38-28T 170MM | BOTTOM BRACKET: SHIMANO BB-UN100 122,5MM | CASSETTE/COG: SHIMANO MF-TZ500 14-28T 7S | CHAIN: KMC Z50 | RIM: BERETTA MT240E 28" 36H | FRONT HUB: FORMULA FM21 36H | REAR HUB: FORMULA FM31 36H | SPOKE: STEEL | RACK: - | MUDGUARD: - | CHAIN COVER: - | PEDAL: XERAMA SP872N PP



MTB

BORN TO BE DIRT

The mountain bikes are designed to enable you to take up the real challenges – not considering convenience – of forest lands as well as rocky and rough roads. It does not contain any additional weight that would hinder sporty pedalling. Go off the beaten track and enjoy the challenges!

MTB BICYCLES

ASGARD



△ FRAME	CEPIDA HYDROFORMING - 6061 ALLOY
△ FRAME SIZE	17" 19" 21"
○ WHEEL SIZE	29"
⌒ FORK	ROCKSHOX RECON TK 29" 100MM QR15 CROWN TAPERED
⚙️ GEARS	22
📖 WEIGHT	14,2 KG

ARTICLE NUMBER
30200090

29"

🛑 BRAKE	SHIMANO ACERA BR-M395
👉 FRONT DERAILLEUR	SHIMANO SLX FD-M7025 DOWN SWING DUAL PULL 34,9MM
👈 REAR DERAILLEUR	SHIMANO SLX RD-M7000-11 GS SHADOW+ 11S
🌀 TYRE	SCHWALBE RAPID ROB 29X2,25
🚽 SADDLE	VELO VL-3315 W/ GEL
💡 LIGHT	-

COLOR
30200090A

HEAD SET: FSA NO.42B | STEM: CEPIDA/TRANZX JDST-58A EXT: 80/90/100MM | HANDLE BAR: PROMAX HB-3018DBFT FLAT TOP 720MM BB: 31,8MM | GRIP: VELO VLG-775-12D2 + VLP-171 | BRAKE LEVER: SHIMANO ACERA BL-M425 | BRAKE DISC F/R: SHIMANO RT-54M 180MM / RT-54S 160MM | SHIFTING LEVER: SHIMANO SLX SL-M7000-11 2X11S | SEAT POST: PROMAX SP-226 31,6X400MM | CRANKSET: SHIMANO SLX FC-MT600 36-26T, 170/175MM | BOTTOM BRACKET: SHIMANO DEORE SM-BB52 | CASSETTE/COG: SHIMANO SLX CS-M7000 11-40T 11S | CHAIN: SHIMANO CN-HG601-11 11S | RIM: RODI BLACKROCK 29" 32H | FRONT HUB: SHIMANO DEORE HB-M6010 QR15 32H | REAR HUB: SHIMANO DEORE FH-M6000 QR 32H | SPOKE: SAPIM STAINLESS STEEL BLACK | RACK: - | MUDGUARD: - | CHAIN COVER: - | PEDAL: XERAMA SP-610 ALLOY W/ CATEYE

RUGA



△ FRAME	GEPIDA HYDROFORMING - 6061 ALLOY	🔧 BRAKE	SHIMANO ALTUS BR-M365
△ FRAME SIZE	17" 19" 21"	👉 FRONT DERAILLEUR	SHIMANO ALTUS FD-M2000 DOWN SWING DUAL PULL 34,9MM
○ WHEEL SIZE	29" 27,5"	👉 REAR DERAILLEUR	SHIMANO DEORE RD-M592 SHADOW 9S
⌒ FORK	SUNTOUR XCR32 COIL LO-R DS 29" 100MM QR	🌀 TYRE	SCHWALBE SMART SAM 29X2,1 HS476
⚙️ GEARS	27	👉 SADDLE	VELO VL-3315 W/ GEL
📖 WEIGHT	15,08 KG	💡 LIGHT	-

ARTICLE NUMBER **30200080** 29" ARTICLE NUMBER **30200070** 27,5"

COLOR	COLOR
30200080A	30200070A

HEAD SET: FSA NO.11N | STEM: GEPIDA/TRANZX JDST-58A EXT: 80/90/100MM | HANDLE BAR: GEPIDA ALLOY 720 MM DB FLAT TOP BB: 31,8MM | GRIP: VELO VLC-775-12D2 + VLP-171
 BRAKE LEVER: SHIMANO ALTUS BL-M365 | BRAKE DISC F/R: SHIMANO DEORE RT-56M 180MM / RT-56S 160MM | SHIFTING LEVER: SHIMANO ACERA SL-M3000 3X9S | SEAT POST: KALLOY SPDC1 31,6X400MM | CRANKSET: SUNTOUR XCM-T410 OC 40-30-22T 170/175MM | BOTTOM BRACKET: SHIMANO BB-ES300 OCTALINK 113MM | CASSETTE/COG: SHIMANO ACERA CS-HG201 11-32T 9S | CHAIN: SHIMANO CN-HG53 9S | RIM: BERETTA DISC25 29" 622X19C / RODI BLACKROCK 27,5" 584X21C 32H | FRONT HUB: FORMULA DC-20LW QR 32H | REAR HUB: FORMULA DC-22W QR 32H | SPOKE: SAPIM STAINLESS STEEL BLACK | RACK: - | MUDGUARD: - | CHAIN COVER: - | PEDAL: XERAMA SP-610 ALLOY W/ CATEYE

SIRMIUM



△ FRAME	6061 ALLOY	🔧 BRAKE	SHIMANO ALTUS BR-M315
△ FRAME SIZE	17" 19" 21"	👉 FRONT DERAILLEUR	SHIMANO TY FD-TY700 TOP SWING DUAL PULL 34,9MM
○ WHEEL SIZE	29"	👉 REAR DERAILLEUR	SHIMANO ACERA RD-M3000 SGS SHADOW
⌒ FORK	ZOOM VAXA 29" HL 100MM	🌀 TYRE	WTB-FREEDOM CUTLASS 29X2,1
⚙️ GEARS	24	👉 SADDLE	SELLE ROYAL SETA S1
📖 WEIGHT	15,6 KG	💡 LIGHT	-

ARTICLE NUMBER **30200060** 29"

COLOR	COLOR
30200060A	30200060B

HEAD SET: FSA NO.11Q | STEM: KALLOY AS601 BB: 31,8MM EXT: 75/90/105MM | HANDLE BAR: PROMAX HB-3018DBFT FLAT TOP 720MM BB: 31,8MM | GRIP: VELO VLC-207 KRATON
 BRAKE LEVER: SHIMANO ALTUS BL-M315 | BRAKE DISC F/R: SHIMANO RT-26M 180MM / RT-26S 160MM | SHIFTING LEVER: SHIMANO ALTUS SL-M310 3X8S | SEAT POST: KALLOY SPDC1 31,6X400MM | CRANKSET: SUNTOUR XCC-T202 42-32-22T 170/175MM | BOTTOM BRACKET: SHIMANO BB-UN100 122,5MM | CASSETTE/COG: SHIMANO ALTUS CS-HG31 11-32T 8S | CHAIN: KMC Z72 | RIM: BERETTA DISC25 29" 622X19C | FRONT HUB: FORMULA DC-20 QR 32H | REAR HUB: FORMULA DC-22 QR 32H | SPOKE: SAPIM STEEL BLACK | RACK: - | MUDGUARD: - | CHAIN COVER: - | PEDAL: XERAMA SP-940 PP/STEEL W/ CATEYE

SIRMIUM



△ FRAME 6061 ALLOY

△ FRAME SIZE 17" 19" 21"

○ WHEEL SIZE 27,5"

└ FORK ZOOM VAXA 650B HL 100MM

⚙ GEAR 24

⚖ WEIGHT 15,2 KG

ARTICLE NUMBER
30200050

🔑 BRAKE SHIMANO ALTUS BR-M315

👉 FRONT DERAILLEUR SHIMANO TY FD-TY700 TOP SWING DUAL PULL 34,9MM

👉 REAR DERAILLEUR SHIMANO ACERA RD-M3000 SGS SHADOW

🌀 TYRE WTB-FREEDOM CUTLASS 27,5X2,1

📏 SADDLE VELO VL-3315 W/ GEL

💡 LIGHT -

COLOR
 30200050A
 30200050B

HEAD SET: FSA NO.11Q | STEM: KALLOY AS601 BB: 31,8MM EXT: 75/90/105MM | HANDLE BAR: PROMAX HB-3188 RIZER 720MM BB: 31,8MM | GRIP: VELO VLG-207 KRATON | BRAKE LEVER: SHIMANO ALTUS BL-M315 | BRAKE DISC F/R: SHIMANO RT-26M 180MM / RT-26S 160MM | SHIFTING LEVER: SHIMANO ALTUS SL-M310 3X8S | SEAT POST: KALLOY SPD1 31,6X400MMG | CRANKSET: SUNTOUR XCC-T202 42-32-22T 170/175MM | BOTTOM BRACKET: SHIMANO BB-UN100 122,5MM | CASSETTE/COG: SHIMANO ALTUS CS-HG31 11-32T 8S | CHAIN: KMC Z72 | RIM: BERETTA DISC25 27,5" 584X19C | FRONT HUB: FORMULA DC-20 QR 32H | REAR HUB: FORMULA DC-22 QR 32H | SPOKE: SAPIM STEEL BLACK | RACK: - | MUDGUARD: - | CHAIN COVER: - | PEDAL: XERAMA SP-940 PP/STEEL W/ CATYE

MUNDO PRO



△ FRAME 6061 ALLOY

△ FRAME SIZE 17" 19" 21"

○ WHEEL SIZE 27,5"

└ FORK ZOOM VAXA 650B HL 100MM

⚙ GEAR 21

⚖ WEIGHT 15,2 KG

ARTICLE NUMBER
30200040

🔑 BRAKE SHIMANO BR-TX805

👉 FRONT DERAILLEUR SHIMANO TY FD-TY500 TOP SWING DUAL PULL 34,9MM

👉 REAR DERAILLEUR SHIMANO ACERA RD-M360 SGS 7/8S

🌀 TYRE WTB-FREEDOM GANGSTER 27,5X1,95

📏 SADDLE SELLE ROYAL MACH

💡 LIGHT -

COLOR
 30200040A

HEAD SET: FSA NO.11Q | STEM: KALLOY AS601 BB: 25,4MM EXT: 70/90MM 7DEG | HANDLE BAR: PROMAX HB-M301 640MM BB: 25,4MM | GRIP: VELO VLG-207 KRATON | BRAKE LEVER: SHIMANO ST-EF 41 | BRAKE DISC F/R: SHIMANO RT-26S 160MM | SHIFTING LEVER: SHIMANO ST-EF 41 3X7S | SEAT POST: GEPIDA ALLOY SP-C207 31,6X400MM | CRANKSET: SUNTOUR XCC-T202 42-32-22T 170/175MM | BOTTOM BRACKET: SHIMANO BB-UN100 122,5MM | CASSETTE/COG: SHIMANO CS-HG200 12-32T 7S | CHAIN: KMC Z50 | RIM: BERETTA DISC25 27,5" 584X19C | FRONT HUB: FORMULA DC-20 QR 32H | REAR HUB: FORMULA DC-22-7 QR 32H | SPOKE: SAPIM STEEL BLACK | RACK: - | MUDGUARD: - | CHAIN COVER: - | PEDAL: XERAMA SP-400 PP W/ CATYE

MUNDO



△ FRAME	6061 ALLOY	👤 BRAKE	GEPIDA V-BRAKE TX-118
△ FRAME SIZE	15" 17" 19" 21"	👤 FRONT DERAILLEUR	SHIMANO TY FD-TY510 TOP SWING DUAL PULL 34,9MM
○ WHEEL SIZE	26"	👤 REAR DERAILLEUR	SHIMANO TY RD-TY300D
⌒ FORK	ZOOM BRAVO 410E 26" 50MM	👤 TYRE	WTB-FREEDOM GANGSTER 26X1,95
⚙️ GEARS	21	👤 SADDLE	SELLE ROYAL MACH
📖 WEIGHT	14,3 KG	👤 LIGHT	-
ARTICLE NUMBER	30200030	COLOR	
	26"		

HEAD SET: FSA NO.11Q | STEM: KALLOY AS601 BB: 25,4MM EXT: 70/90MM 7DEG | HANDLE BAR: PROMAX HB-M301 600MM BB: 25,4MM | GRIP: VELO VLG-207 KRATON | BRAKE LEVER: SHIMANO ST-EF 41 | BRAKE DISC F/R: - | SHIFTING LEVER: SHIMANO ST-EF 41 3X7S | SEAT POST: GEPIDA ALLOY SP-C207 31,6X400MM | CRANKSET: PROWHEEL A541 48-38-28T 170MM | BOTTOM BRACKET: SHIMANO BB-UN100 122,5MM | CASSETTE/COG: SHIMANO MF-TZ500 14-28T 7S | CHAIN: KMC Z50 | RIM: BERETTA MT-240 26" 36H | FRONT HUB: FORMULA FM21 QR 36H | REAR HUB: FORMULA FM31 QR 36H | SPOKE: SAPIM STEEL BLACK | RACK: - | MUDGUARD: - | CHAIN COVER: - | PEDAL: XERAMA SP-400 PP W/ CATEYE

MUNDO LS



△ FRAME	6061 ALLOY LADY	👤 BRAKE	GEPIDA V-BRAKE TX-118
△ FRAME SIZE	16"	👤 FRONT DERAILLEUR	SHIMANO TY FD-TY510 TOP SWING DUAL PULL 34,9MM
○ WHEEL SIZE	26"	👤 REAR DERAILLEUR	SHIMANO TY RD-TY300D
⌒ FORK	ZOOM BRAVO 410E 26" 50MM	👤 TYRE	WTB-FREEDOM GANGSTER 26X1,95
⚙️ GEARS	21	👤 SADDLE	SELLE ROYAL MACH
📖 WEIGHT	14,3 KG	👤 LIGHT	-
ARTICLE NUMBER	30200036	COLOR	
	26"		

HEAD SET: FSA NO.11Q | STEM: KALLOY AS601 BB: 25,4MM EXT: 75MM 15DEG | HANDLE BAR: PROMAX HB-M301 600MM BB: 25,4MM | GRIP: VELO VLG-207 KRATON | BRAKE LEVER: SHIMANO ST-EF 41 | BRAKE DISC F/R: - | SHIFTING LEVER: SHIMANO ST-EF 41 3X7S | SEAT POST: GEPIDA ALLOY SP-C207 31,6X400MM | CRANKSET: PROWHEEL A541 48-38-28T 170MM | BOTTOM BRACKET: SHIMANO BB-UN100 122,5MM | CASSETTE/COG: SHIMANO MF-TZ500 14-28T 7S | CHAIN: KMC Z50 | RIM: BERETTA MT-240 26" 36H | FRONT HUB: FORMULA FM21 QR 36H | REAR HUB: FORMULA FM31 QR 36H | SPOKE: SAPIM STEEL BLACK | RACK: - | MUDGUARD: - | CHAIN COVER: - | PEDAL: XERAMA SP-400 PP W/ CATEYE



URBAN

CAPTURE THE CITY

Our urban bikes endowed with perfect geometry and small wind resistance are able to reach very large speeds. They are at their best in an urban environment on asphalt and not least they provide a stylish appearance. They are equally suitable for sporty performance biking and hobby use.

The design of the city frame geometry ensures your full comfort, as you can sit on the bike with a straight posture, thus you can cross the city, pedal to your workplace or do a smaller shopping easily. To put it in a nutshell: it is the perfect partner in everyday life.

URBAN & CITY BICYCLES

SPESIS



△ FRAME	SS STEEL	👉 BRAKE	GEPIDA RC-452 CFA
△ FRAME SIZE	54, 58CM	👉 FRONT DERAILLEUR	-
○ WHEEL SIZE	28"	👉 REAR DERAILLEUR	-
⌒ FORK	STEEL	👉 TYRE	WTB/FREEDOM ROADRUNNER 700X25C
⚙️ GEARS	1	👉 SADDLE	VELO VLG-1356
📖 WEIGHT	9,9 KG	👉 LIGHT	-

ARTICLE NUMBER
30200110

COLOR	👉	👉	👉	30200110B
	👉	👉	👉	30200110A
	👉	👉	👉	30200110C

HEAD SET: FSA NO.20 | STEM: GEPIDA/TRANZX JDST-58A EXT: 70MM | HANDLE BAR: GEPIDA ALLOY W: 680MM RISE: 25MM BB: 25,4MM | GRIP: VELO VLG-775-12D2 + VLP-171 | BRAKE LEVER: PROMAX FS-373 | BRAKE DISC F/R: - | SHIFTING LEVER: - | SEAT POST: GEPIDA ALLOY SP-C207 25,4X300MM | CRANKSET: PROWHEEL 246 46T 165 MM | BOTTOM BRACKET: FSA BB-7420ST 113MM | CASSETTE/COG: SINGLE SPEED 16T | CHAIN: KMC Z410 | RIM: RODI AIRLINE4 622X13C | FRONT HUB: FORMULA TH50 36H | REAR HUB: FORMULA TH51 36H | SPOKE: SAPIM STEEL BLACK | RACK: - | MUDGUARD: - | CHAIN COVER: - | PEDAL: VP 536 PP W/ CATEYE

S3



△ FRAME	SS STEEL	🔑 BRAKE	GEPIDA RC-452
△ FRAME SIZE	M: 54, 58CM	👉 FRONT DERAILLEUR	-
○ WHEEL SIZE	28"	👉 REAR DERAILLEUR	-
⌒ FORK	STEEL	🌀 TYRE	INNOVA 700X23C
⚙️ GEARS	1	👉 SADDLE	VELO VLG1356
📖 WEIGHT	10 KG	🔑 LIGHT	-

ARTICLE NUMBER
30200100

COLOR		30200100C
		30200100A
		30200100B
		30200100E

HEAD SET: **ALLOY A-HEAD** | STEM: **TRANZ-X 80MM** | HANDLE BAR: **GEPIDA ALLOY FLAT 440 MM** | GRIP: **VELO VLG-076 BROWN** | BRAKE LEVER: **GEPIDA ALLOY 239A** | BRAKE DISC F/R: - | SHIFTING LEVER: - | SEAT POST: **GEPIDA ALLOY 25,4X300 SP-232** | CRANKSET: **PROWHEEL 246 46T/165 MM** | BOTTOM BRACKET: **NECO 113,5 MM** | CASSETTE/COG: **SINGLE SPEED 16T** | CHAIN: **KMC Z410 WHITE** | RIM: **RODI AIRLINE 4 700C 36HH** | FRONT HUB: **FORMULA ALLOY 36H** | REAR HUB: - | SPOKE: - | RACK: - | MUDGUARD: - | CHAIN COVER: - | PEDAL: -

BANDON 810



△ FRAME	6061 ALLOY	🔑 BRAKE	GEPIDA RC-452 CFA
△ FRAME SIZE	M: 52, 54, 56, 58, 60CM	👉 FRONT DERAILLEUR	SHIMANO CLARIS FD-2403 31,8MM
○ WHEEL SIZE	28"	👉 REAR DERAILLEUR	SHIMANO CLARIS RD-2400
⌒ FORK	ALLOY	🌀 TYRE	SCHWALBE LUGANO 700X25C
⚙️ GEARS	24	👉 SADDLE	SELLE ROYAL VIPER
📖 WEIGHT	10 KG	🔑 LIGHT	-

ARTICLE NUMBER
30200170

COLOR		30200170A
-------	--	------------------

HEAD SET: **GEPIDA INTEGRATED A-HEAD** | STEM: **GEPIDA, TDS-D507B OS 80, 100, 110MM** | HANDLE BAR: **GEPIDA ALLOY OS 400, 420, 440MM** | GRIP: **VELO VLT-004 BAR TAPE** | BRAKE LEVER: **SHIMANO ST-2403** | BRAKE DISC F/R: - | SHIFTING LEVER: **SHIMANO CLARIS ST-2403 3X8S** | SEAT POST: **GEPIDA ALLOY SP-C207 27,2X300MM** | CRANKSET: **SHIMANO CLARIS FC-2403 30-39-50T/170 MM** | BOTTOM BRACKET: **SHIMANO BB-ES300 OCTALINK** | CASSETTE/COG: **SHIMANO HG50-8 12-23T** | CHAIN: **KMC Z72 8S** | RIM: **RODI STYLUS 700C 36H** | FRONT HUB: **FORMULA RB31 QR 36H** | REAR HUB: **FORMULA RB30 QR 36H** | SPOKE: **SAPIM STEEL BLACK** | RACK: - | MUDGUARD: - | CHAIN COVER: - | PEDAL: -

REPTILA 500 M



△ FRAME	GEPIDA HYDROFORMING - 6061 ALLOY	🚫 BRAKE	SHIMANO ALIVIO BR-T4000 V-BRAKE+COASTER
△ FRAME SIZE	54, 58CM	👉 FRONT DERAILLEUR	-
○ WHEEL SIZE	28"	👉 REAR DERAILLEUR	SHIMANO NEXUS 8
⌒ FORK	SUNTOUR CR7-V 700C 40 MM	🌀 TYRE	SCHWALBE ROAD CRUISER 42-622 W/ REFLECTIVE TAPE
⚙️ GEARS	8	🚽 SADDLE	SELLE ROYAL ESSENZA ACTTEX COVER
🏠 WEIGHT	18 KG	💡 LIGHT	AXA ECHO15/SLIM DELAYED

ARTICLE NUMBER

30200450

COLOR

30200450A

HEAD SET: **GEPIDA SEMI-INTEGRATED** | STEM: **GEPIDA MQ-417 EXT: 80MM BB: 25,4MM** | HANDLE BAR: **GEPIDA NR-14 STEEL W: 600MM BB: 25,4MM** | GRIP: **VELO VLG-690AD2** | BRAKE LEVER: **GEPIDA ALLOY LM-48** | BRAKE DISC F/R: - | SHIFTING LEVER: **SHIMANO REVOSHIFT NEXUS 8** | SEAT POST: **HL HARMONY SUSPENSION 27,2X300MM** | CRANKSET: **PROWHEEL 38T/170 MM** | BOTTOM BRACKET: **SHIMANO BB-UN100** | CASSETTE/COG: **STURMEY ARCHER 19T** | CHAIN: **KMC Z410** | RIM: **RODI SKORPION 28" 32H** | FRONT HUB: **SHIMANO HUBDYNAMO** | REAR HUB: **SHIMANO NEXUS 8 COASTER 32H** | SPOKE: **SAPIM STAINLESS** | RACK: **MASSLOAD CL-550** | MUDGUARD: **SKS** | CHAIN COVER: - | PEDAL: **XERAMA SP809 PP W/ CATEYE**

REPTILA 500 W



△ FRAME	GEPIDA HYDROFORMING - 6061 ALLOY	🚫 BRAKE	SHIMANO ALIVIO BR-T4000 V-BRAKE+COASTER
△ FRAME SIZE	45, 50CM	👉 FRONT DERAILLEUR	-
○ WHEEL SIZE	28"	👉 REAR DERAILLEUR	SHIMANO NEXUS 8
⌒ FORK	SUNTOUR CR7-V 700C 40 MM	🌀 TYRE	SCHWALBE ROAD CRUISER 42-622 W/ REFLECTIVE TAPE
⚙️ GEARS	8	🚽 SADDLE	SELLE ROYAL ESSENZA ACTTEX COVER
🏠 WEIGHT	18 KG	💡 LIGHT	AXA ECHO15/SLIM DELAYED

ARTICLE NUMBER

30200455

COLOR

30200455A

COLOR

30200455B

HEAD SET: **GEPIDA SEMI-INTEGRATED** | STEM: **GEPIDA MQ-417 EXT: 80MM BB: 25,4MM** | HANDLE BAR: **GEPIDA NR-14 STEEL W: 600MM BB: 25,4MM** | GRIP: **VELO VLG-690AD2** | BRAKE LEVER: **GEPIDA ALLOY LM-48** | BRAKE DISC F/R: - | SHIFTING LEVER: **SHIMANO REVOSHIFT NEXUS 8** | SEAT POST: **HL HARMONY SUSPENSION 27,2X300MM** | CRANKSET: **PROWHEEL 38T/170 MM** | BOTTOM BRACKET: **SHIMANO BB-UN100** | CASSETTE/COG: **STURMEY ARCHER 19T** | CHAIN: **KMC Z410** | RIM: **RODI SKORPION 28" 32H** | FRONT HUB: **SHIMANO HUBDYNAMO** | REAR HUB: **SHIMANO NEXUS 8 COASTER 32H** | SPOKE: **SAPIM STAINLESS** | RACK: **MASSLOAD CL-550** | MUDGUARD: **SKS** | CHAIN COVER: - | PEDAL: **XERAMA SP809 PP W/ CATEYE**

REPTILA 200 NX3



△ FRAME	6061 ALLOY	🚒 BRAKE	LOGAN ALLOY V-BRAKE + COASTER
△ FRAME SIZE	W: 45, 50 CM	👣 REAR SHOCK	-
○ WHEEL SIZE	ZOOM 141 28" TRAVEL: 45MM	🛠 REAR DERAILLEUR	SHIMANO NEXUS 3
⌒ FORK	28"	🌀 TYRE	WTB/FREEDOM CONVERT 700 X 45C W/ REFLECTIVE TAPE
⚙ GEAR	3	🚽 SADDLE	JUSTEK UN5509
📖 WEIGHT	18,2 KG	💡 LIGHT	BÜCHEL UNILED 15 / AXA X-RAY W/ STANDLIGHT
ARTICLE NUMBER	30200425		
	COLOR		
	30200425A	30200425B	

HEADSET: FSA TH807ST THREADED 1 1/8" | STEM: GEPIDA MQ-417 EXT: 80MM BB: 25,4MM | HANDLEBAR: GEPIDA STEEL CITY 158 600MM BB: 25,4MM | GRIP: VELO VLG-428D2 | BRAKE LEVER: LOGAN ALLOY/PLASTIC 4-FINGER | SHIFTING LEVER: SHIMANO NEXUS 3 SL-3S41 | SEATPOST: GEPIDA ALLOY SP-C207 27,2X300MM | CRANKARM: PROWHEEL 38T/170 MM | CASSETTE/COG: STURMEY ARCHER 19T | CHAIN: KMC Z410 | RIM: BERETTA MT240 28" 36H | FRONT HUB: SHIMANO DH-C3000-3N 6V 3W 36H | REAR HUB: SHIMANO NEXUS 3 SG-3C41 36H | SPOKE: STEEL | RACK: STEEL | MUDGUARD: ORION BLACK W/ STEEL STAYS | PEDAL: XERAMA SP872N PP W/ CATEYE

REPTILA 100



△ FRAME	STEEL	🚒 BRAKE	LOGAN ALLOY V-BRAKE + COASTER
△ FRAME SIZE	45 CM	👣 FRONT DERAILLEUR	-
○ WHEEL SIZE	28"	🛠 REAR DERAILLEUR	SHIMANO NEXUS 3
⌒ FORK	STEEL	🌀 TYRE	WTB/FREEDOM CONVERT 700X38C
⚙ GEAR	3	🚽 SADDLE	JUSTEK UN5509
📖 WEIGHT	18,2 KG	💡 LIGHT	BÜCHEL UNILED 15 / AXA X-RAY W/ STANDLIGHT
ARTICLE NUMBER	30200485		
	COLOR		
	30200485A	30200485B	30200485C

HEAD SET: STEEL BLACK | STEM: GEPIDA MQ-417 EXT: 80MM BB: 25,4MM | HANDLE BAR: GEPIDA STEEL CITY 158 W: 600MM BB: 25,4MM | GRIP: VELO VLG-428D2 | BRAKE LEVER: LOGAN ALLOY/PLASTIC 4-FINGER | BRAKE DISC F/R: - | SHIFTING LEVER: SHIMANO NEXUS 3 SL-3S41 | SEAT POST: GEPIDA STEEL 28.6X300MM | CRANKSET: PROWHEEL FTR 38T 170MM | BOTTOM BRACKET: THUN BASIC PLUS 120MM | CASSETTE/COG: STURMEY ARCHER 19T | CHAIN: KMC Z410 | RIM: BERETTA MT240E 28" 36H | FRONT HUB: SHIMANO DH-C3000-3N 6V 3W 36H | REAR HUB: SHIMANO NEXUS 3 SG-3C41 36H | SPOKE: STEEL | RACK: STEEL | MUDGUARD: ORION BLACK W/ STEEL STAYS | CHAIN COVER: - | PEDAL: XERAMA SP872N PP W/ CATEYE

REPTILA 50/100



△ FRAME	STEEL	🚰 BRAKE	LOGAN ALLOY V-BRAKE + COASTER
△ FRAME SIZE	44 CM	👉 FRONT DERAILLEUR	-
○ WHEEL SIZE	26"	👉 REAR DERAILLEUR	SHIMANO NEXUS 3
⌒ FORK	STEEL	🌀 TYRE	WTB/FREEDOM CONVERT 700X38C
⚙️ GEARS	3	🚲 SADDLE	JUSTEK UN5509
📖 WEIGHT	17,4 KG	💡 LIGHT	BÜCHEL KB 50/75 HALOGEN / X-RAY W/ STANDLIGHT

ARTICLE NUMBER
30200405

26"

COASTER
BREAK

ARTICLE NUMBER
30200415

28"

COASTER
BREAK

COLOR		30200405B	
	30200405A		30200405C
COLOR		30200415B	
	30200415A		30200415C

HEAD SET: STEEL BLACK | STEM: GEPIDA MQ-417 EXT: 80MM BB: 25,4MM | HANDLE BAR: GEPIDA STEEL CITY 158 W: 600MM BB: 25,4MM | GRIP: VELO VLG-428D2 | BRAKE LEVER: LOGAN ALLOY/PLASTIC 4-FINGER | BRAKE DISC F/R: - | SHIFTING LEVER: SHIMANO NEXUS 3 SL-3S41 | SEAT POST: GEPIDA STEEL 28.6X300MM | CRANKSET: PROWHEEL FTR 38T 170MM | BOTTOM BRACKET: THUN BASIC PLUS 120MM | CASSETTE/COG: STURMEY ARCHER 19T | CHAIN: KMC Z410 | RIM: BERETTA MT-240 26" 36H | FRONT HUB: FORMULA FM21 36H | REAR HUB: SHIMANO NEXUS 3 SG-3C41 36H | SPOKE: STEEL | RACK: STEEL | MUDGUARD: ORION BLACK W/ STEEL STAYS | CHAIN COVER: - | PEDAL: XERAMA SP872N PP W/ CATEYE

CLASSIC



△ FRAME	GEPIDA 6061 ALLOY	🚰 BRAKE	GEPIDA TX-117 V-BRAKE + COASTER
△ FRAME SIZE	48, 52CM	👉 FRONT DERAILLEUR	-
○ WHEEL SIZE	28"	👉 REAR DERAILLEUR	SHIMANO NEXUS 3
⌒ FORK	ALLOY	🌀 TYRE	SCHWALBE BIG APPLE KEVLARGUARD 28X2.0
⚙️ GEARS	3	🚲 SADDLE	SELLE ROYAL DRIFTER
📖 WEIGHT	17,6 KG	💡 LIGHT	BÜCHEL RETRO CHROME / BEETLE W/ STANDLIGHT

ARTICLE NUMBER
30200125

COASTER
BREAK

COLOR		30200125A		30200125B
-------	--	-----------	--	-----------

HEAD SET: FSA TH-1150W | STEM: GEPIDA ALLOY HAC40 | HANDLE BAR: GEPIDA NR-AL3 ALLOY 600MM RISE: 64MM BB: 25,4MM | GRIP: VELO VLG-428D2 | BRAKE LEVER: LOGAN 327AE ALLOY 4 FINGER | BRAKE DISC F/R: - | SHIFTING LEVER: SHIMANO NEXUS 3 SL-3S41 | SEAT POST: GEPIDA ALLOY SP-501 27,2X300MM | CRANKSET: PROWHEEL PRO-E40 38T 170MM | BOTTOM BRACKET: SHIMANO BB-UN100 122,5MM | CASSETTE/COG: STURMEY ARCHER 19T | CHAIN: KMC Z410 | RIM: RODI SKORPION CNC 28" 36H | FRONT HUB: SHIMANO DH-C3000-3N 6V 3W 36H | REAR HUB: SHIMANO NEXUS 3 SG-3C41 36H | SPOKE: SAPIM STAINLESS | RACK: STEEL | MUDGUARD: STEEL | CHAIN COVER: - | PEDAL: XERAMA SP-811 ALLOY W/ CATEYE



JUNIOR













FOR THE YOUNGER ONES

The first bicycle is special in a child's life, this is exactly why we put great emphasis on providing them with premium quality even during their first ride. Biking is a game for them, so we placed the emphasis exactly on this: we wanted to design bikes making games really games, bringing joy to the smallest bikers as well.

JUNIOR BICYCLES

GILPIL 50



△ FRAME	STEEL	🔩 BRAKE	GEPIDA LB-936 ALLOY V-BRAKE	
△ FRAME SIZE	35 CM	👉 FRONT DERAILLEUR	STEEL FD-325ST 42T CLAMP: 28,6MM	
○ WHEEL SIZE	24"	🔗 REAR DERAILLEUR	SHIMANO TY RD-TZ500GS	
⌒ FORK	STEEL	🌀 TYRE	WTB-FREEDOM GANGSTER 24X1,95	
⚙️ GEARS	21	📖 SADDLE	SELLE ROYAL PU-6550	
📖 WEIGHT	13,1 KG	💡 LIGHT	-	
ARTICLE NUMBER		COLOR		
30200605		 	 	30200605B
		 	 	30200605A
		 	 	30200605C

HEAD SET: STEEL BLACK | STEM: GEPIDA STEEL LS100 BB: 25,4MM EXT: 60MM | HANDLE BAR: GEPIDA STEEL HB-M201 W: 560MM BB: 25,4MM | GRIP: VELO VLG-213 KRATON | BRAKE LEVER: LL-338PAE 2FINGER JUNIOR | BRAKE DISC F/R: - | SHIFTING LEVER: SHIMANO TY SL-RS35 REVOSHIFT 3X6S | SEAT POST: GEPIDA STEEL 25,4X250MM | CRANKSET: PROWHEEL MY-A543 42-34-24T 152MM | BOTTOM BRACKET: THUN BASIC PLUS 120MM | CASSETTE/COG: SHIMANO MF-TZ500 14-28T 6S | CHAIN: KMC HP20 | RIM: BERETTA P24 24" 36H | FRONT HUB: ASSESS STEEL CAPNUT 36H | REAR HUB: ASSESS STEEL CAPNUT 36H | SPOKE: STEEL | RACK: - | MUDGUARD: - | CHAIN COVER: XERAMA SP872N PP W/ CATEYE | PEDAL: XERAMA SP-811 ALLOY W/ CATEYE

URBAN E-BIKE | **BONUM PRO** SLX 10 | 30202435



URBAN E-BIKE | **BONUM PRO** NEXUS 8 | 30202455



URBAN E-BIKE | **BONUM** SLX 10 | 30202405



URBAN E-BIKE | **BONUM** NEXUS 8 | 30202415



URBAN E-BIKE | **BONUM CURVE** NEXUS 8 | 30201425



URBAN E-BIKE | **BONUM CURVE** ALTUS 9 | 30201465



URBAN E-BIKE | **PUGIO** NEXUS 7 | 30201550

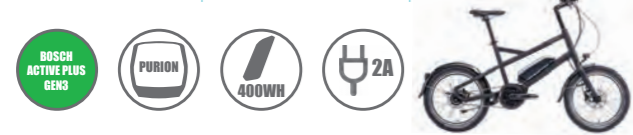

URBAN E-BIKE | **LEGIO PRO** ALFINE 8 | 30202220



SPECIAL E-BIKE | **CARGO** NUVINCI 330 | 30202505

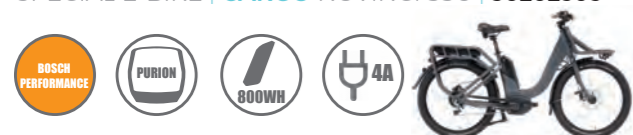

SPECIAL E-BIKE | **TURISIND LS** ALFINE 8 | 30202236



SPECIAL E-BIKE | **TURISIND CITY** ALFINE 8 | 30202235



SPECIAL E-BIKE | **CASSIS PRO** ULTEGRA DI2 11 | 30200860



SPECIAL E-BIKE | **CASSIS** 105 | 30200850



SPECIAL E-BIKE | **CASSIS GRAVEL** GRX 400 | 30200840

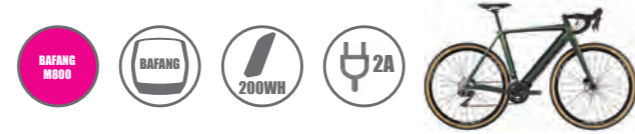

CITY E-BIKE | **REPTILA 1000+** NEXUS 8C | 30201375



CITY E-BIKE | **REPTILA 1000** DEORE 10 | 30201335



CITY E-BIKE | **REPTILA 1000** NEXUS 8/8C | 30201325, 30201355



CITY E-BIKE | **REPTILA 900** NEXUS 8/8C | 30201315, 30201345

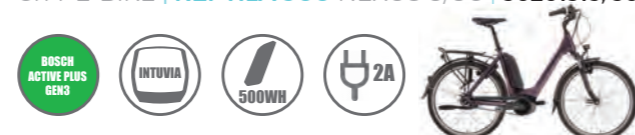

CITY E-BIKE | **REPTILA 1000** NEXUS 7C | 30201305



CITY E-BIKE | **REPTILA 800** ALTUS 7 | 30201385



CITY E-BIKE | **REPTILA 800** ALTUS 7 | 30201395



CITY E-BIKE | **REPTILA 1000** NEXUS 7C RT | 30201905



CITY E-BIKE | **REPTILA 1000** NEXUS 7 RT | 30201985



CITY E-BIKE | **CRISIA** NEXUS 7C BAF-M | 30200935

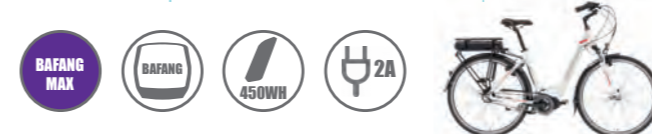

CITY E-BIKE | **CRISIA** ALTUS 7 BAF-M | 30200915



CITY E-BIKE | **CRISIA** ALTUS 7 BAF-F | 30200965

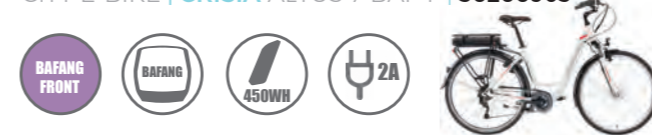

TREKKING E-BIKE | **FASTIDA PRO** XT 10 | 30202270

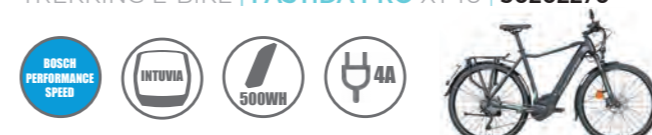

TREKKING E-BIKE | **FASTIDA** XT 10 | 30202260



TREKKING E-BIKE | **ALBOIN PRO** XT 10 | 30202280



TREKKING E-BIKE | **ALBOIN PRO LS** XT 10 | 30202286



TREKKING E-BIKE | **ALBOIN CURVE** ALFINE 8 | 30202250



TREKKING E-BIKE | **ALBOIN CURVE LS** ALFINE 8 | 30202256



TREKKING E-BIKE | **ALBOIN CURVE** DEORE 10 | 30201290



TREKKING E-BIKE | **ALBOIN CURVE LS** DEORE 10 | 30201296

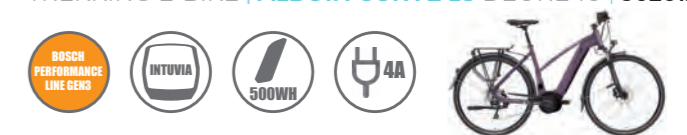

TREKKING E-BIKE | **ALBOIN** ALIVIO 9 | 30202240

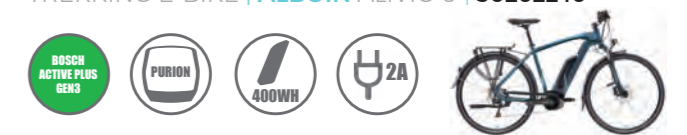

TREKKING E-BIKE | **ALBOIN LS** ALIVIO 9 | 30202246

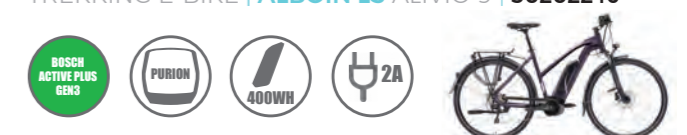

TREKKING E-BIKE | **TISIA** ALIVIO 9 BAF-M | 30200970



TREKKING E-BIKE | **TISIA LS** ALIVIO 9 BAF-M | 30200976



TREKKING E-BIKE | **THORIS VOYAGE** XT 10 | 30202600



TREKKING E-BIKE | **THORIS** XT 10 | 30202560



MTB & ATB E-BIKE | **ASGARD PRO** XT 11 | 30202080



MTB & ATB E-BIKE | **ASGARD** XT 10 | 30202070



MTB & ATB E-BIKE | **RUGA PRO** DEORE 10 | 30202030



MTB & ATB E-BIKE | **RUGA PRO** DEORE 10 | 30202050



MTB & ATB E-BIKE | **SIRMIUM PRO** DEORE 10 | 30202040



MTB & ATB E-BIKE | **SIRMIUM** DEORE 9 | 30202000



MTB & ATB E-BIKE | **SIRMIUM** DEORE 9 | 30202010



MTB & ATB E-BIKE | **BERIC** DEORE 10 | 30202580



MTB & ATB E-BIKE | **BERIC** DEORE 10 | 30202570



MTB & ATB E-BIKE | **BERIC LS** DEORE 10 | 30202575



MTB & ATB E-BIKE | **GILPIL** ALIVIO 9 | 30201540



THE ROAD
IS JUST
AN OPTION

YOUR GEPIDA DEALER:

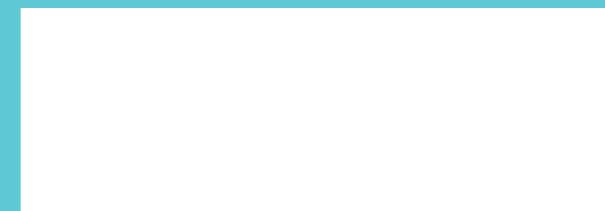

THE ROAD
IS JUST AN OPTION



OLIMPIA BICYCLE LTD.

-
- H-1164 Budapest, Ostorhegy st. 4.
 - +36 1 400 6065
 - +36 1 402 0084
 - info@gepida.com
 - www.gepida.com
 - facebook.com/gepida